

## DOCUMENT RESUME

ED 310 946

SE 050 903

TITLE Discovery.  
INSTITUTION Smithsonian Institution, Washington, D.C. National Air And Space Museum.  
SPONS AGENCY National Aeronautics and Space Administration, Washington, D.C.  
REPORT NO NASA-PED-105  
PUB DATE 89  
NOTE 85p.; Drawings may not reproduce well.  
PUB TYPE Guides - Classroom Use - Guides (For Teachers) (052)

EDRS PRICE MF01/PC04 Plus Postage.  
DESCRIPTORS \*Aerospace Education; Aviation Vocabulary; Early Childhood Education; Elementary School Science; \*Primary Education; Satellites (Aerospace); \*Science Activities; \*Science History; Science Interests; \*Science Materials; Space Exploration; \*Space Sciences

## ABSTRACT

This material presents the historical perspectives of flight and student activities for grades K-3 prepared by the National Air and Space Museum (NASM) and National Aeronautics and Space Administration (NASA). Sections included are: (1) "Historical Perspective of Flight"; (2) "Discovery Vocabulary" (listing the terms found in the first section); (3) "Pre-Visit Activities"; (describing four activities to be accomplished before a tour of NASM); (4) "Classroom Activities" (presenting 30 activities); (5) "Reproducible Activities" (providing 18 activities); (6) "Solutions to Reproducible Activities"; (7) "NASA and NASM Resource Centers" (listing addresses of Teacher Resource Centers); and (8) "Study Prints" (containing 12 pictures with their descriptions). (YP)

\*\*\*\*\*  
\* Reproductions supplied by EDRS are the best that can be made \*  
\* from the original document. \*  
\*\*\*\*\*

ED810946

# DISCOVERY

U

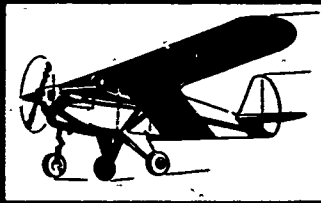

**U.S. DEPARTMENT OF EDUCATION**  
 Office of Educational Research and Improvement  
**EDUCATIONAL RESOURCES INFORMATION CENTER (ERIC)**

This document has been reproduced as received from the person or organization originating it.

Minor changes have been made to improve reproduction quality.

• Points of view or opinions stated in this document do not necessarily represent official OERI position or policy.



SE 050 903

# NASA

# DISCOVERY

Preface . . . . .	2
Historical Perspective of Flight . . . . .	3
Discovery Vocabulary . . . . .	6
Pre-Visit Activities . . . . .	7
Classroom Activities . . . . .	11
Reproducible Activities . . . . .	19
Solutions to Reproducible Activities . . . . .	47
NASA and NASM Resource Centers . . . . .	49
Study Prints . . . . .	51

Prepared by  
the National Air and Space Museum  
Smithsonian Institution  
in collaboration with  
the National Aeronautics  
and Space Administration

## Preface

**T**he Historical Perspective of Flight and Student Activities are for grades K-3. They deal with aviation history, not aerodynamics. The activities may be used in any of the following ways:

1. Teachers may direct large or small groups;
2. Students may direct their own activities; or
3. Teachers may write activities on cards for students to choose and perform independently or in small groups.

Directions, length of time, and depth of involvement will need to be adjusted to the students' individual interests, needs, and abilities. Students may perform some activities before a Discovery tour, or visit to the National Air and Space Museum.

Words that appear in bold-face type can be used as a lesson vocabulary. A list of Discovery Vocabulary words can be found on page eight. Whoever conducts the activity should present the words in written form during discussion. This may be done by writing the words on a chalkboard or by showing them on cards.

The Study Prints of artifacts in the museum can be used for classroom discussions and display.

# Historical Perspective of Flight

*Teacher Note:* This brief historical overview of air and space flight is for teacher information.

Ever since humans first saw birds soar through the sky, they have wanted to fly. The ancient **Greeks** and **Romans** pictured many of their gods with wings on the shoulders or feet, and imaged mythological winged animals such as **Pegasus**, the horse, who flew through the skies. According to the legend of **Daedalus** and **Icarus**, the father and son escaped prison by attaching wings made of wax and feathers to their bodies. Unfortunately, Icarus flew too near the Sun, and the heat caused the wax to melt. The feathers fell off, and Icarus plummeted to the sea. Daedalus landed safely in Sicily.



These were all stories, however. It was not until the 1700s that a person actually went up into the air in a craft. That first successful recorded flight was in a hot-air balloon built by the **Montgolfier brothers**. Balloons became so



popular that in France they were used for everything—sports, travel, warfare. Balloons became the subjects of adventure stories.

During the late 1700s and early 1800s in England, **Sir George Cayley** designed the modern fixed-wing **airplane**, rather than trying to imitate the flapping of bird wings. He built models of gliders, then tested full-scale versions of his designs. Cayley's work inspired a generation of engineers who took the final steps toward developing the airplane. The development of the airplane became an international effort, with contributions from **Clement Ader** of France, **Hiram Maxim** of England, **Otto Lilienthal** of Germany, and **Samuel Langley** and **Octave Chanute** of the United States.

On December 17, 1903, two brothers from Dayton, Ohio, named **Wilbur** and **Orville Wright**, were successful in flying an airplane that they built. Their powered aircraft flew for 12 seconds above the sand dunes of

**Kitty Hawk, North Carolina**, making them the first persons to pilot a heavier-than-air machine that took off with its own power, remained under control, and sustained flight.

It was an exciting time, luring other inventors to follow the path of the Wright brothers. In the United States, as well as in other countries, many people learned to make flying machines; soon everyone seemed

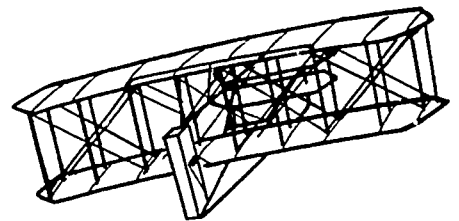

to want airplanes that were bigger and better. Aviation "firsts" happened one after the other during those early days. For instance, **Calbraith P. Rodgers**, flying the **Wright EX "Vin Fiz,"** made the first cross-country flight in 1911. The trip was not non-stop, however. It took 49 days, and Rodgers landed more than 80 times. **Lieutenant James Doolittle** crossed the United States in one day, making only fuel stops, in 1922. In 1923, **Lieutenants Oakley G. Kelly** and **John A. Macready** made the first nonstop flight across the United States in their **Fokker T-2**.

Thousands cheered in 1927 when **Charles A. Lindbergh** in the "**Spirit of St. Louis**" completed the first solo transatlantic

flight. He flew from New York City to Paris, France, in 33½ hours. **Amelia Earhart** became the first woman to fly solo and nonstop across the Atlantic in 1932 in the **Lockheed 5-B Vega**. Record after record was set.

**N**ew uses for the airplane became evident during World Wars I and II. Because the airplane could find and attack an enemy quickly and effectively, it changed battlefield strategy forever. After World War II, aircraft were developed to exceed the speed of sound. **Captain Charles "Chuck" Yeager** piloted the **Bell X-1** named "**Glamorous Glennis**"

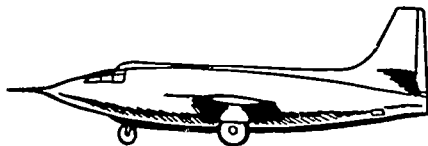

faster than the speed of sound—1,078 kilometers (670 miles per hour)—at 13,106 meters (43,000 feet) altitude on October 14, 1947. No one knew what would happen when Yeager "broke the sound barrier," but his bullet-shaped X-1 reached 1,127 kilometers (700 miles) per hour at 13,106 meters (43,000 feet) without damage.

In another five years, the idea for the **X-15** was conceived. Ultimately, the X-15 rocket aircraft flew over six times the speed of sound and set an unofficial altitude record of 108 kilometers (67 miles) above the surface of Earth.

**P**art of the ancient dream of flying was to leave Earth and journey to the stars. Rockets were part of that dream, too. According to one story, a man in ancient China, named **Wan Hu**, fastened a bundle of firecrackers to his chair and attempted to **launch** himself into space. Unfortunately, after lighting the fireworks, Wan Hu was never seen again.

In the 13th century, the Chinese fought their enemies by firing rockets attached to poison-tipped arrows. This idea was copied by other nations for several hundred years. Then, in the late 1700s **Sir William Congreve** developed the incendiary and case shot rockets for the British to use against the French. Because these fire-producing rockets were not very accurate, the British had to fire many at once to make sure they hit their target.

**T**he first appearance of the rocket in America was during the War of 1812 at Fort McHenry, in Baltimore, Maryland. **Francis Scott Key** watched the Congreve "rockets' red glare" from a ship in the harbor, and was inspired to write "**The Star Spangled Banner**," our national anthem.

Modern rockets actually were researched and designed in the early 1900s by several scientists in different parts of the world. **Dr. Robert H. Goddard**, a professor of physics, researched and developed the first liquid-fueled rockets. After 17 years of theoretical

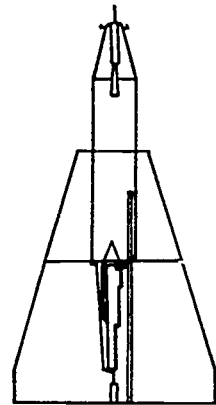

and experimental work, Dr. Goddard finally achieved flight of a liquid-fueled rocket in the United States in 1926. Dr. Goddard hoped to send his rockets into the atmosphere to measure temperature and atmospheric pressure.

During World War II, rockets were developed into weapons, which subsequently led to rockets powerful enough to launch objects into **orbit** around Earth.

**S**putnik, launched by the Soviet Union on October 4, 1957, was the first artificial satellite. **Explorer** was launched on January 31, 1958, by the United States Army. Several months later, on October 1, 1958, a new U.S. agency was created, the **National Aeronautics and Space Administration (NASA)** "devoted to peaceful purposes for the benefit of all mankind." Since

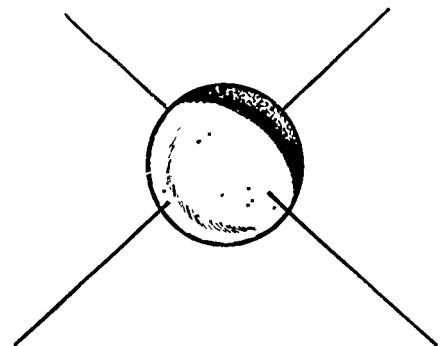

NASA's first satellite was launched in 1960, many different kinds of **spacecraft** have been sent into our solar system.

**E**ventually humans flew into space. Since the 1960s, the United States and the Soviet Union have launched several kinds of spacecraft carrying astronauts beyond Earth's atmosphere. The United States launched a three-part manned space program. The **Project Mercury** Program, the first part,

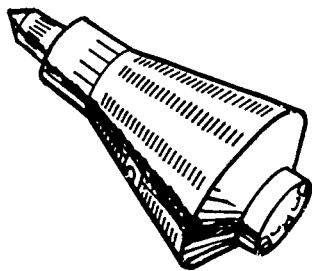

used a one-man spacecraft, and on May 5, 1961, the suborbital flight of **Alan B. Shepard, Jr.**, successfully put the first American in space. On February 20, 1962, **John H. Glenn** became the first American to complete three Earth orbits in space in the **Friendship 7**. A two-man spacecraft was used for the second part, the **Gemini** Program, and a three-man spacecraft for the third part, the **Apollo** Program.

The overall goal of the three spaceflight programs was to reach the Moon. During the Apollo 11 mission on July 20, 1969, astronauts **Neil A. Armstrong** and **Edwin E. "Buzz" Aldrin, Jr.**,

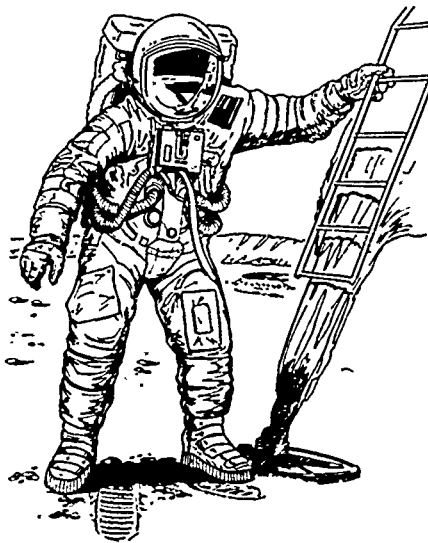

became the first humans to step onto the Moon as **Michael Collins** orbited the Moon in the command module.

**Skylab**, launched by NASA in 1973, was the first United States space station. Skylab helped scien-

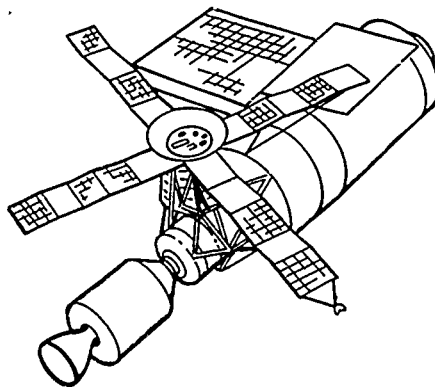

tists learn about human ability to study and work in space for up to three months. In 1975, the United States and the Soviet Union cooperated in a space mission; an Apollo spacecraft linked in orbit with a **Soviet Soyuz** spacecraft.

The American astronauts met and worked in space with the Soviet cosmonauts.

**T**he **Space Shuttle**, or **Space Transportation System (STS)**, is the first reusable spacecraft designed for routine use in space. The Space Shuttle reduces the cost of space operations. It deploys payloads; repairs, services, and retrieves satellites; and serves as a base for research. The first flight of the **STS** proved it was feasible for a spacecraft to land on the ground and to be reused for additional flights later on. The crew on the first flight, **STS-1**, on April 12-14, 1981, were **John Young** and **Robert Crippin** on the spacecraft **Columbia**.

Imagine, in less than 100 years, people have learned to fly, have traveled in space, and have set foot on the Moon! What will we be doing in another 100 years?

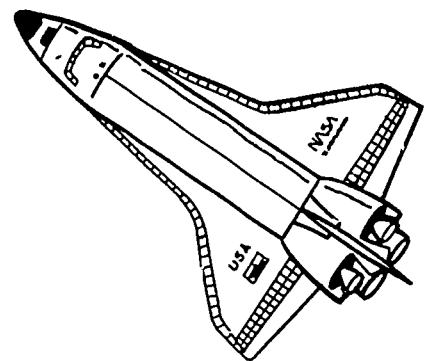



# Discovery Vocabulary

These vocabulary words are found in the Historical Perspective of Flight for Teachers and in the Pre-Visit and Classroom Activity sections.

Clement Ader

airplane

Edwin E. "Buzz" Aldrin, Jr.

Apollo

Neil A. Armstrong

artifacts

aviation

balloonists

Bell X-1

biplane

Sir George Cayley

Octave Chanute

Michael Collins

Columbia

Sir William Congreve

Robert Crippin

Daedalus

docent

Lieutenant James Doolittle

Amelia Earhart

engines

Explorer

Fokker T-2

Friendship 7

galleries

Gemini

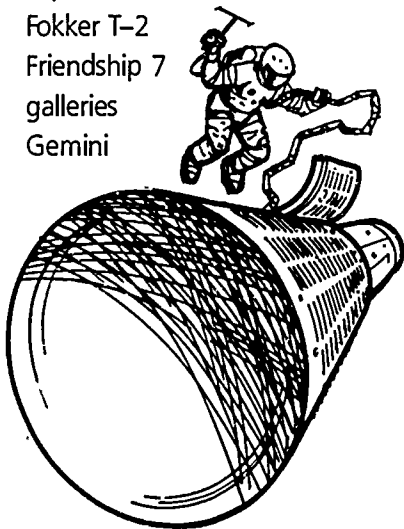

Glamorous Glennis

John H. Glenn, Jr.

Dr. Robert H. Goddard

Greeks

Wan Hu

Icarus

jet engines

Lieutenant Oakley G. Kelly

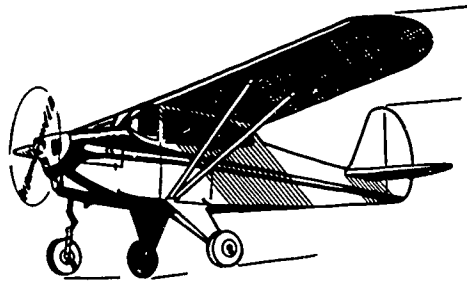

Francis Scott Key

Kitty Hawk, North Carolina

Samuel Langley

launch

lighter-than-air

Otto Lilienthal

Charles A. Lindbergh

Lockheed 5-B Vega

Lieutenant John A. Macready

Hiram Maxim

monoplane

Montgolfier brothers

museum

national

National Advisory Committee for Aeronautics (NACA)

National Aeronautics and Space Administration (NASA)

orbit

Pegasus

Project Mercury

propeller

Calbraith P. Rodgers

Romans

Alan B. Shepard, Jr.

Skylab

Soviet Soyuz

Space Shuttle

Space Transportation System (STS)

spacecraft

Spirit of St. Louis

Sputnik

The Star Spangled Banner

Orville Wright

Wilbur Wright

Wright EX Vin Fiz

X-15

Captain Charles "Chuck" Yeager

John Young

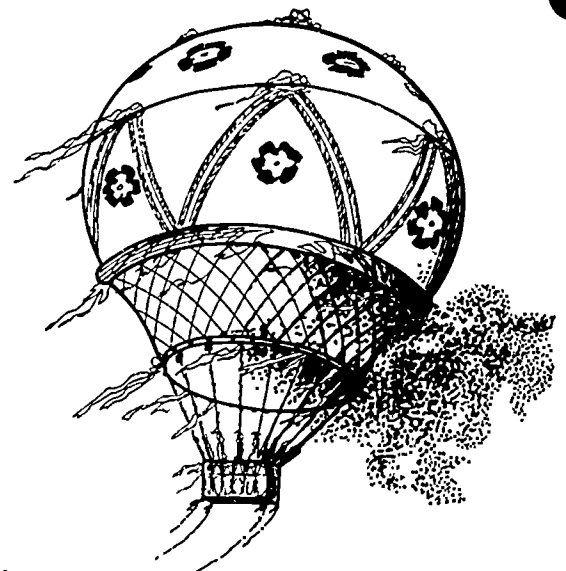



# Pre-Visit Activities

The following four activities should be accomplished before a docent-led Discovery tour at the National Air and Space Museum

\*Teacher Note: Bold-faced words used in the Historical Perspective of Flight for Teachers and Pre-Visit and Classroom Activities sections are vocabulary words. A complete listing of these words is found in the Discovery Vocabulary. Prior to your tour or lesson, make sure students are familiar with the words.

## Activity

1

Lead the students in a discussion about **museums**. What does the word **national** mean in National Air and Space Museum? Explain to the students that their tour group will be led by a **docent**, or guide, who describes and explains the **artifacts** in the museum. An artifact is an object in a museum used to show a particular stage of technological development. In the National Air and Space Museum, many of the artifacts show the history of human involvement with flight. Why is it important to listen carefully to the docent? The docent will guide students to many different **galleries**. Galleries are rooms or special areas in the museum.

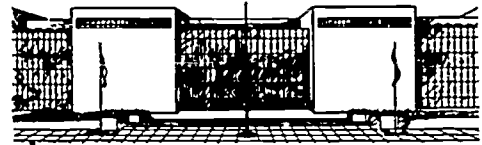

Discuss what is appropriate behavior when visiting a museum. How can we, as good citizens, help keep our national museums in good condition?

## Activity

2

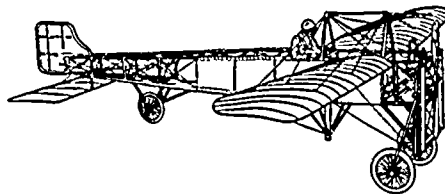

Discuss with students how early airplanes were powered by **engines** turning a **propeller**. Although most modern small aircraft are still propeller driven, today's large commercial airliners and military aircraft use

**jet engines**. Distinguish between the propeller- and jet-driven aircraft and spacecraft that are launched into orbit by huge rockets. Lead the students in a discussion of the differences. Depending on students' abilities, include a comparison about the altitudes to which various balloons, aircraft, and spacecraft have traveled into the atmosphere or space. If one is not available in a basic textbook, obtain a chart depicting various layers of the atmosphere.

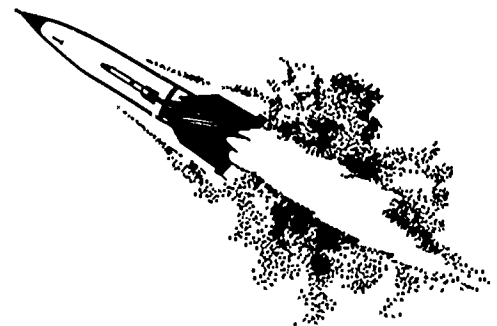
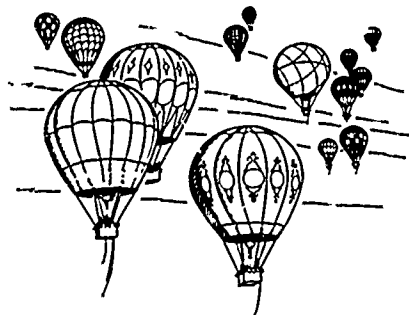

## Activity

# 3

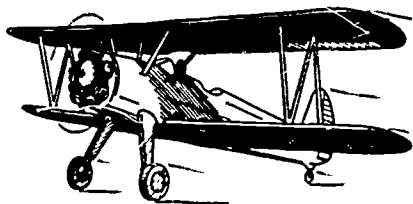

Discuss the prefix "bi." Ask students, how many wheels does a *bicycle* have? How many sets of wings does a **biplane** have in the front? Ask students to find a picture of a biplane. Tell them most planes we see today are called **monoplanes** because they have only one set of wings in the front, and then suggest students draw a picture of a biplane. Remind students to look for a biplane when they are on their Discovery tour.

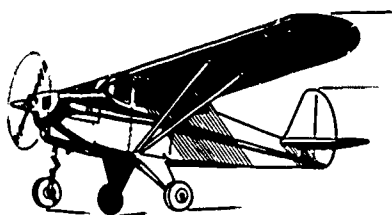

## Activity

# 4

In this activity basic shapes outline the nametag patterns for ease of cutting. Lead the students in a discussion of how these basic shapes relate to aircraft, e.g., some wings are nearly rectangular while others tend to be triangular. (Shapes are on the next page.)

For students not visiting the museum, cut the patterns and then color for mobiles, bulletin board decorations, or a collage.

# Pre-Visit Activity

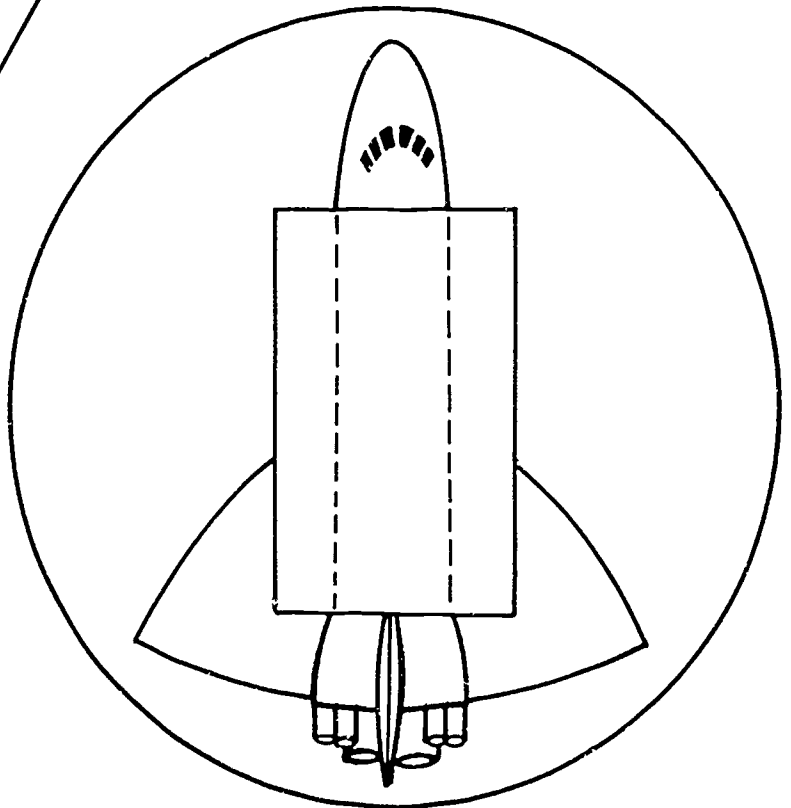
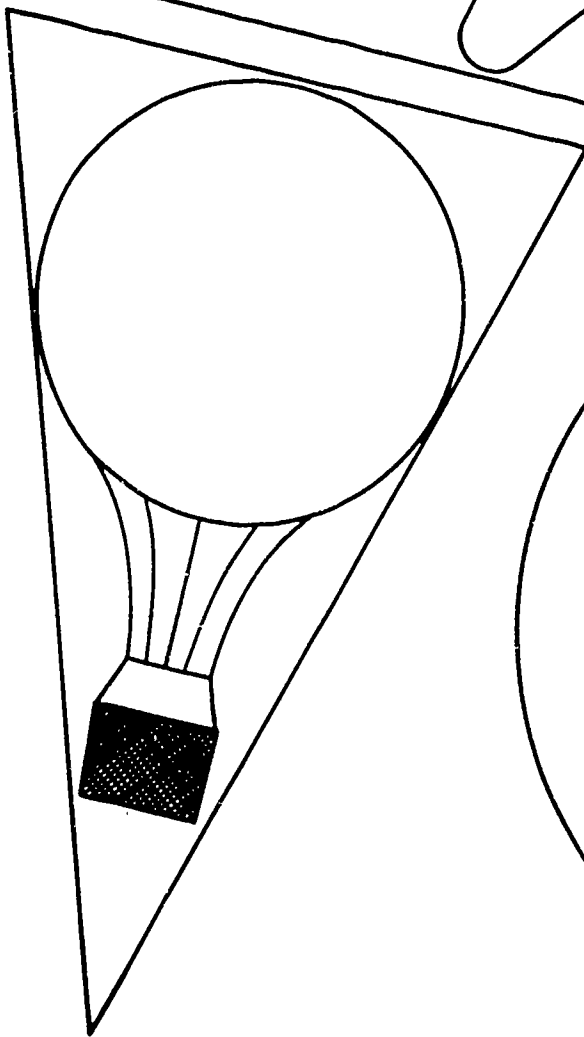
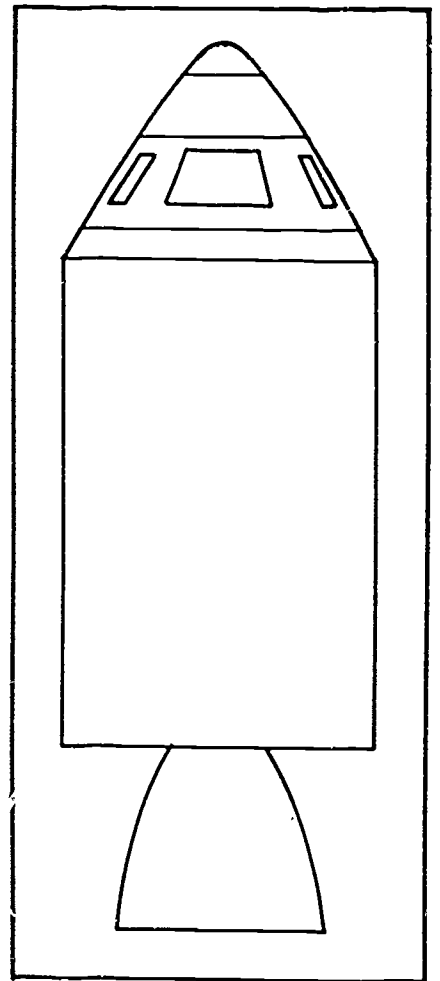
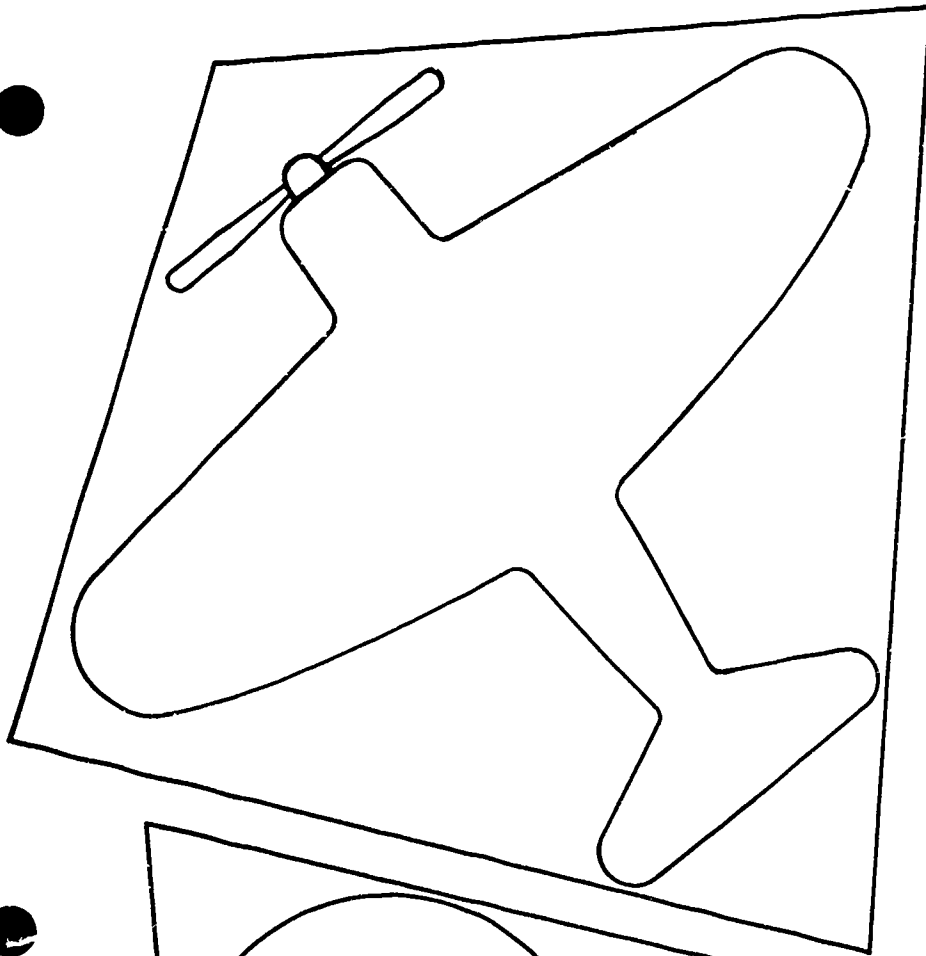

## Classroom Activities

### Activity

1

Have your students collect feathers from as many different birds as possible. Let them examine the feathers. Compare the shapes of the feathers with the wings of airplanes. Have the student make a drawing, showing how they are alike. Mount and label the collection of feathers. Share the story of Daedalus and Icarus with the class.

### Activity

2

Hot-air balloons have been used for everything—sports, travel, and warfare. Have the students write an adventure story using a hot-air balloon. Another approach might be to create a “chain” adventure story with several friends. Have one person start the story, telling a short part, then have the next person add to it, and so on. You may want to tape-record the “chain” story. (Choose an “ending” person!)



### Activity

3

On the museum tour the class will visit briefly the Balloons and Airships Gallery to see a model of a **lighter-than-air** craft used for people’s first voyages in the atmosphere. In the classroom watch the drifting of materials that float on air, such as cotton, hair, dandelion seeds, milkweed seeds, etc. Sprinkle a small amount of talcum powder or cornstarch a few inches above a hot light bulb. The students should observe the currents caused by the rising heated air. Ask: How can **balloonists** control their craft? What problems might they encounter?

### Activity

4

Ask the students the following questions: Have you ever heard the saying, “Two heads are better than one”? What does it mean? Why does working together often get better results than working alone? When might it be best to work alone?

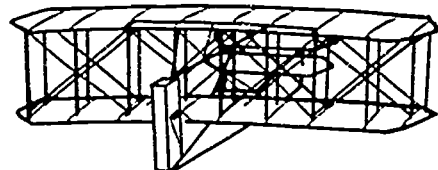

Have students tell about a time they worked with someone on a project. Ask: Did you have any problems? How did you work them out?

Tell the students to imagine they are one of the Wright brothers or Montgolfier brothers. Then ask them: What problems do you think the Wright or Montgolfier brothers might have had to solve about working together? Have students team up in pairs and act this out.

## Activity

5

Students may role-play by pretending they are pilots of early aircraft and have just landed in a foreign country where airplanes have never been seen. The pilots cannot speak the language of the natives. Have students write a story about the country, the people, and how the pilots will communicate what they are doing in the foreign country.

## Activity

6

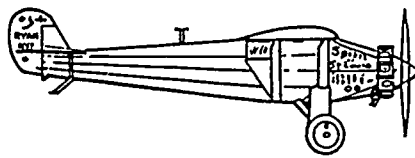

Charles Lindbergh's flight across the Atlantic lasted 33½ hours. Space inside his plane, the Spirit of St. Louis, was very crowded. Have the students

make a list of what they think he took with him. He took a life raft but not a parachute. Why did he make this decision? Have the students try to find out what Lindbergh actually took along with him.

## Activity

7

Using basic shapes, have the students make model airplanes from salt-dough clay, or self-hardening clay. After the models are dry, let students paint the models with tempera or enamel. Hangers may be added before drying so models can be used as ornaments, or hung from the ceiling. Boxes, cans, and other scraps may be used to construct a model airport. Tell the students to park their planes at the airport.

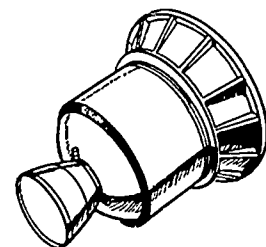
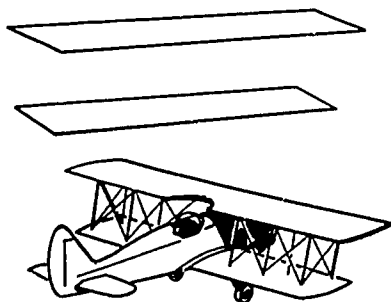
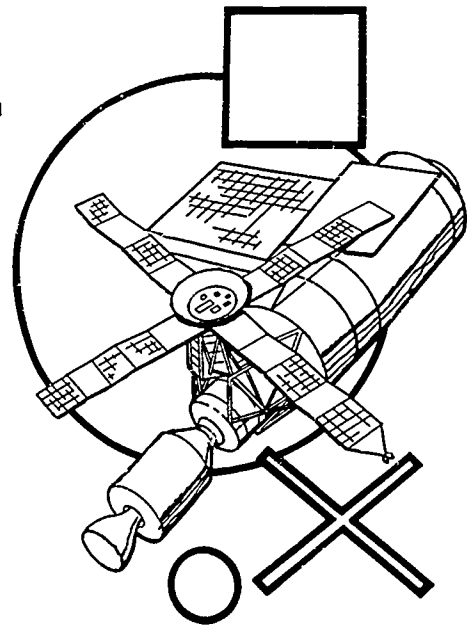

## Classroom Activities

### Activity

8

There are three divisions, or kinds, of **aviation**: (1) general aviation, (2) military, and (3) commercial. General aviation includes aircraft used for business, air taxi, rental, personal transportation, sport flying, flight instruction, air ambulance, and agriculture. Ask the students if they know what airports are in the area. Let them make a list and identify which kind of aviation each uses. (An airport may serve more than one kind of aviation.) Let the students collect items related to aviation—models, photos, magazine pictures, etc. Then let them group the items according to the three divisions. The students may want to make posters and label the items.

### Activity

9

Ask the students: Have you or any of your friends flown in an aircraft? What kind was it—general, military, or commercial? Let students discuss with their friends how big the different airplanes are, how they look inside, what they carry, how many people may be aboard, and how fast they travel. Have students draw a picture of an aircraft they have flown in or one in which they would like to fly.

### Activity

10

Many people work hard to make flights on a commercial aircraft safe, easy, and pleasant. Brainstorm with the class to make a list of these people and what they do. With several students, role-play these jobs. Discuss what happens. Have students draw a picture showing some of the different people at work.

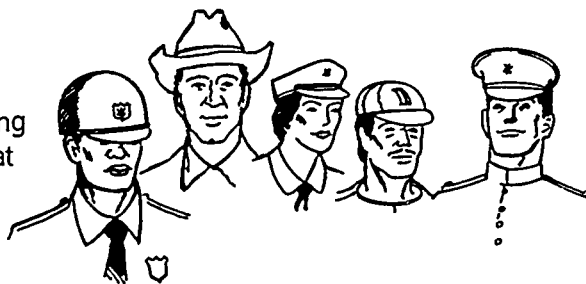

### Activity

11

Since 1962, U.S. military aircraft have used the same letter identification system. For example, the Bell X-1 was an experimental (X) aircraft that was part of a cooperative program initiated in 1944 by the **National Advisory Committee for Aeronautics (NACA)** and the U.S. Army Air Force.

The students should collect articles or headlines from newspapers and magazines that mention aircraft using such identification. (Some of the more familiar are A-attack; B-bomber; C-cargo; F-fighter; T-trainer; and X-experimental/research.)

## Activity

# 12

In 1920 many countries agreed to a civilian aircraft identification system that also used letters. Have the students look for letters identifying countries when visiting a commercial airport. Some to look for are: N-United States; F-France; C or CF-Canada; D-Germany; JA-Japan; CCCP-Russia; G-Great Britain; B-China. Have students record sightings in a log book.

The students could conduct research to find out what type of identification is used on spacecraft and draw a sketch.

## Activity

# 13

The Saturn V rocket was used to launch the Apollo spacecraft. As an art lesson have the students build small models of the Saturn V launch vehicle.

Use cardboard tubes for the body, a cone-shaped paper cup for the nose, light cardboard for fins, and pieces of plastic drinking straws for the engines. If they want to make a multistage rocket, they may use more tubes.

The students may write a story or play about launching their rockets and what it carried (payload) or helped to launch.

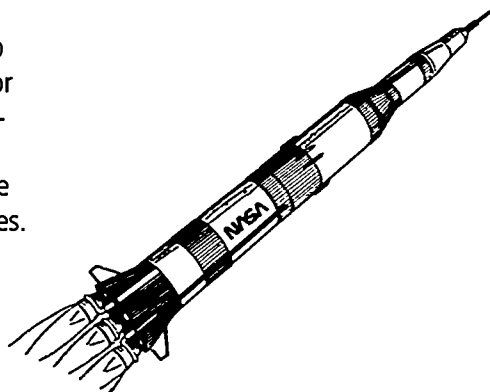

## Activity

# 14

Have students interview an older adult such as a grandparent and ask about Neil Armstrong's first steps on the Moon on July 20, 1969. Students might ask the adult: Where were you? How did you feel? Have the students tape their interview so it can be shared with the class later.

## Activity

# 15

Discuss why some astronauts need to wear spacesuits. Have one student trace around another student's body while he or she lies flat on a large piece of paper. Have students design a spacesuit on this tracing, labeling all the different parts of the suit. Remind students to be sure not to forget any important items! Then have them color the suit and add their nametags.

## Activity

# 16

Astronauts are confined in small spaces for long periods of time. Ask the students: What would you take with you if you were going to be in Skylab for three months? Then let students make a "To Pack" list and try to find out what some astronauts took along.



## Classroom Activities

### Activity

# 17

One Skylab crew spent Christmas in Skylab. Form student groups and let them choose a holiday and plan a celebration for a Skylab crew. Remind them to think of the small area, limited storage, and weightlessness.

### Activity

# 18

Have student groups form companies. The companies have been contracted to design a new spacecraft to be launched 40 years from now. Designs of the outside and inside of the spacecraft can be drawn and displayed in the classroom.

### Activity

# 19

The students can pretend it is 40 years into the future and they have just been launched on a space voyage. Looking out their spacecraft window, they may draw a picture of what they see in space. Be sure they label and color their pictures.



### Activity

# 20

The class can prepare a time capsule filled with student predictions about future space travel and the space station. Students may want to include some present-day artifacts such as photos, news clippings, and drawings in the capsule. Label the capsule with the students' names, the date, and a class photograph, and seal the capsule. Put it away to be opened after 25 years.

### Activity

# 21

Students can pretend they are reporters covering one or more of the important events listed below. A news article reporting what actually happened can be written or told. Remind them that a good reporter tells only facts and writes as clearly as possible, including the answers to *who*, *what*, *when*, *where*, *why*, and *how*.

- The Montgolfier brothers' early balloon flights
- The Wright brothers' first flight
- Charles Lindbergh's crossing of the Atlantic to Paris, France
- Chuck Yeager's flight in the Bell X-1

- John Glenn's first Earth orbital flight
- Neil Armstrong's first steps on the Moon
- John Young and Robert Crippin's first Space Shuttle flight

An interview with one or more of these pioneers can be videotaped "live" in front of the class.

## Activity 22

Students can create "Who Am I?" riddles about famous people in aviation history. The students will write or tell several riddles and make a class book or video. Share the class riddles with other classes.

## Activity 23

In the Discovery activities or tour, students learned about many important people and the role they played in the development of air and space flight. They worked very hard to succeed and their successes have changed lives in many ways. Discuss with classmates how their own lives have been changed by these successes. Have them discuss with an older adult how his or her life has been changed by these accomplishments. Letters of appreciation could be written to one of the people students learned about on the tour or in the activities.

## Activity 24

Have students create paper bag puppets of the famous people they learned about in their Discovery activities or tour. Let them act out a puppet show. Invite parents to visit the class and see the show.

## Activity 25

From the library the students should select a biography about one of the famous people from the Discovery activities or tour. Have students write a short report, turning it into an autobiography. The students can dress like famous persons and share their reports with classmates.

## Activity 26

Have students use a shoebox without a lid, or a cardboard box with one side cut away, to make a diorama of an aircraft or spacecraft from the Discovery activities or tour. Then have the students cover the remaining sides and bottom with construction paper to look like sky. A picture of an aircraft can be drawn and colored, cut out, and suspended by thread over the top. Encourage the students to use their imagination and be as creative as possible.

## Classroom Activities

### Activity 27

Sometimes instead of writing letters, people send postcards. Let the students design a postcard. On the front, they can draw or paste a picture of something they really enjoyed from the Discovery activities. The back of the postcard is divided into two parts. On the left half, students should write a message about what they learned or saw. On the right half, students may address the card to a friend. They may want to design their own postcard stamp.

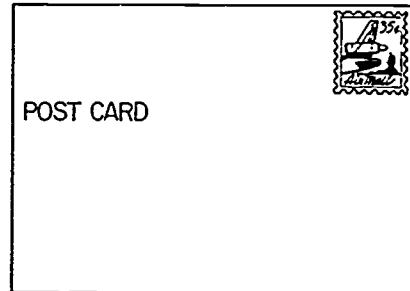

### Activity 28

Let students think of songs that tell about flying. They may use a simple song learned in music class and give it new words that tell about flying, aircraft, spacecraft, or some of the important people in aviation history. Sing the song in class.

Example for composing  
new words to an old tune,  
(Row, Row, Row Your Boat):

Fly, fly, fly your plane

High up in the sky

Fly around, fly around

Fly just like a bird!

### Activity 29

Students may plan a parade to show to the rest of the school the important historical aviation events from the Discovery activities or tour. Small floats (bicycle or red-wagon size) will be in the parade. A prize will be awarded for the most original entry. Let a group of students create their floats and enter them in the parade.

## Activity

# 30

Have the class compose an ABC list of artifacts, people, or terminology they saw or discussed during their Discovery activities or during their tour at NASM. (Possibilities are included for teacher use only!) Younger children might choose (or be assigned) an alphabet letter. Have them draw a picture about the subject and write a short story to accompany the picture. Pictures could be displayed in alphabetical order around the room or along a hallway, or they could be made into a book. Older students could put their ABC pictures on slides or make them into a "movie" using a large carton, gift-wrap tubes, and shelf paper.

- A astronaut; Armstrong (Neil); aviator; aircraft
- B balloon; Bell X-1; biplane
- C Columbia; Command/Service Module; cockpit
- D drag; Discovery; Daedalus
- E Earhart (Amelia); environment; engine; Earth
- F flying; flight; fuel; flaps
- G Goddard (Robert); Glenn (John); gravity
- H helium; hot-air balloon
- I instrument panel; Icarus
- J jet plane; jet engine; jettison
- K Kitty Hawk, North Carolina
- L Lindbergh (Charles); Lunar Module; lift; launch
- M Montgolfier brothers; Mercury; museum; Moon
- N NASM; NASA
- O orbit
- P pilot; propeller; payload; Pegasus
- Q questions
- R rocket; radio; runway; rudder
- S space; Skylab; Saturn 5; spacecraft; Shuttle
- T thrust; triangle; tires; testing; tail
- U up; uplift; USA; uniforms; (space) underwear; upward
- V Vin Fiz; vehicle; voyage
- W Wright brothers; weather; weightless; wheels
- X X-1; X-15
- Y Yeager (Charles); Young (John)
- Z Zulu; zero; zeppelin; zoom; zipper

# Reproducible Activity

## Activity

Match the number from the sentence to the correct matching picture.

1

1. A *monoplane* is an airplane with one set of wings in the front.
2. Some *balloons* are filled with hot air.
3. A *jet airplane* does not have a propeller.
4. A *biplane* is an airplane with two sets of wings in the front.
5. A *rocket* lifts things into space.
6. The *Space Shuttle* carries people into space and returns them to Earth.

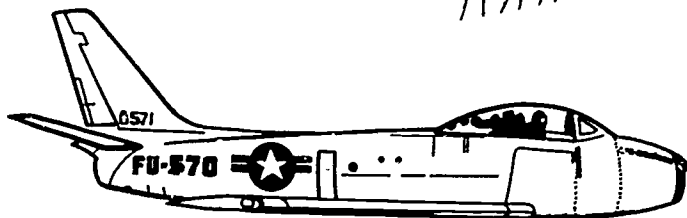
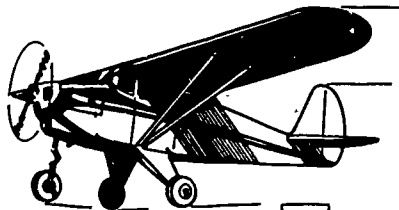
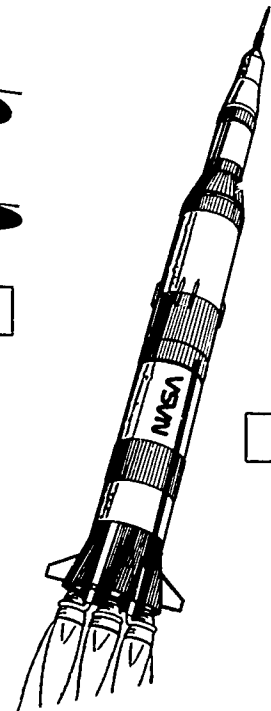
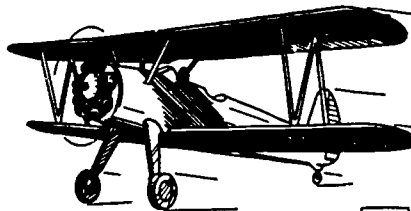
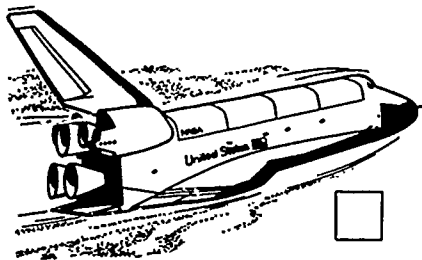

# Reproducible Activity

**Activity** Bell X-1 piloted by Captain Charles "Chuck" Yeager flew faster than the speed of sound at 43,000 feet—1078.7 kilometers (670 miles) per hour—on October 14, 1947.  
**2** Connect the dots. Color "Glamorous Glennis."

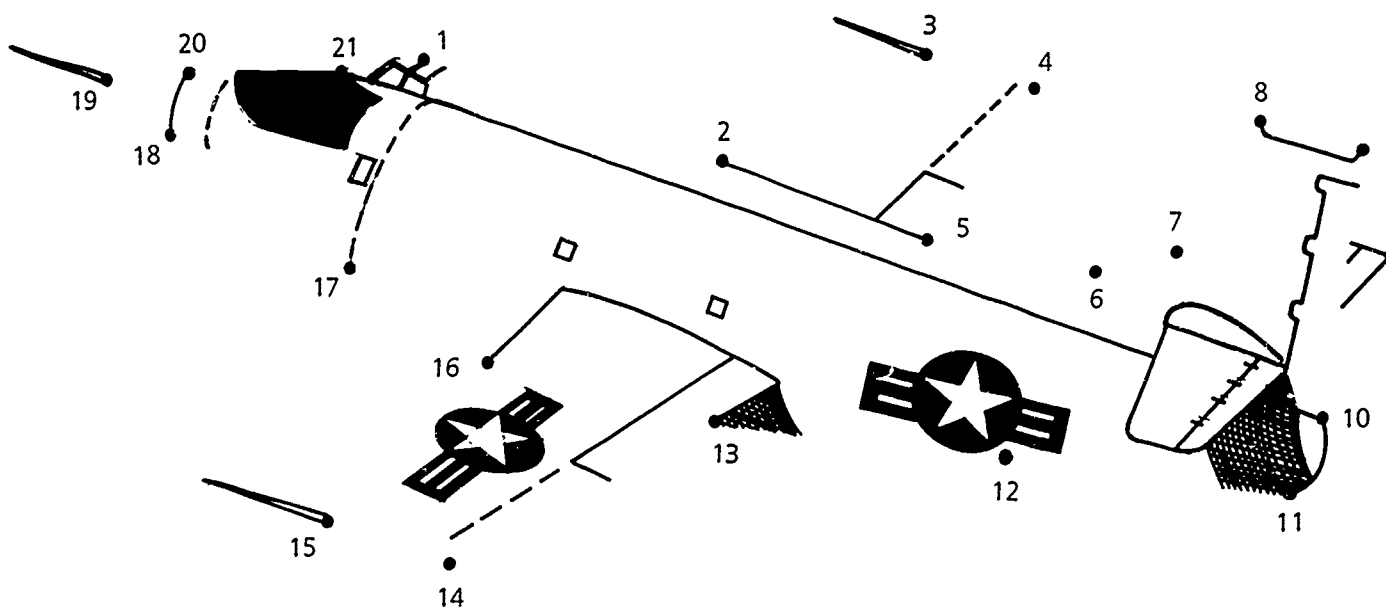

# Reproducible Activity

## Activity

3

An important tool in communicating while in the air or on the ground is the phonetic alphabet. It is used by pilots and others in aviation to help them better understand each other.

In addition all airplanes must have an identification number. This is much like an automobile license tag. Each number starts with a letter to identify its country.

Using the phonetic alphabet chart below, make your own identification number. Start with N for United States, then write the month-number and date of your birthday. (Note: Put zero in front of a single-digit date. For example, May 7 would read 0507 and November 3 would read 1103.) Then add your first and last initials. For example, the identification for Orville Wright, whose birthday is August 19, would be N0819OW. He would identify himself orally on the radio as: "N 0 8 1 9 oscar whiskey."

Write your identification number below, then draw a plane and put your identification number on it. How would you identify yourself orally? \_\_\_\_\_

---

### PHONETIC ALPHABET

A Alfa	J Juliett	S Sierra
B Bravo	K Kilo	T Tango
C Charlie	L Lima	U Uniform
D Delta	M Mike	V Victor
E Echo	N November	W Whiskey
F Foxtrot	O Oscar	X X-ray
G Golf	P Papa	Y Yankee
H Hotel	Q Quebec	Z Zulu
I India	R Romeo	



# Reproducible Activity

**Activity** Study the labeled drawing of the airplane and its parts. Unscramble these words that are related to an airplane.

4

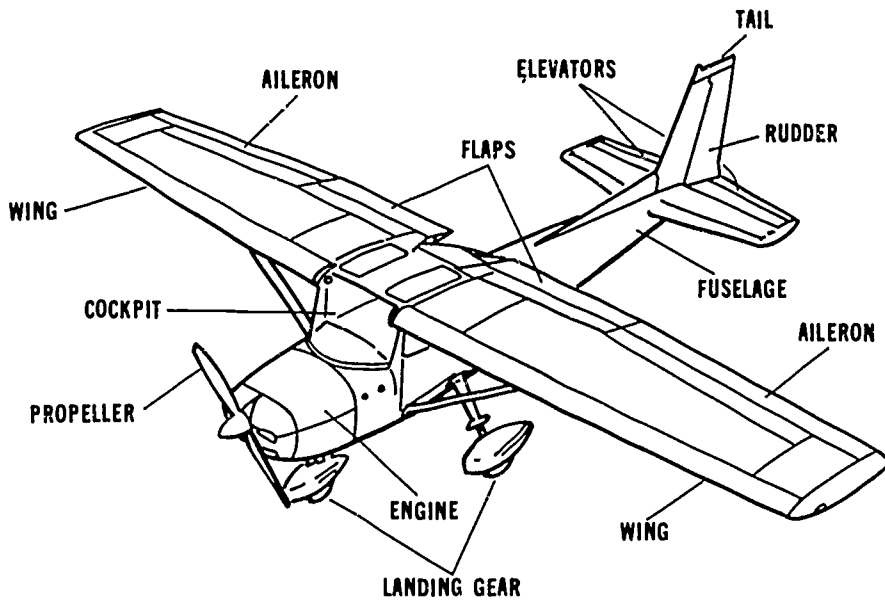

1) sgniw                      dedrur                      useeflag

\_\_\_\_\_

2) potckic                      loreppler                      tolip

\_\_\_\_\_

3) lanieros                      slafp                      dinglan egra

\_\_\_\_\_

4) eelavort                      gernie                      lait

\_\_\_\_\_

*Solution appears on page 47.*

## Reproducible Activity

**Activity** Use the unscrambled words in Reproducible Activity 4 to help you learn some important facts about airplane parts. The number beside each blank is a clue to tell you the row in which the word may be found.

5

A (2) \_\_\_\_\_ is a turning blade on the front of an airplane. The (4) \_\_\_\_\_ turns the propeller, which propels the airplane through the air. The main body portion of an airplane is the (1) \_\_\_\_\_ . The (2) \_\_\_\_\_ flies the plane from the (2) \_\_\_\_\_ where the instruments and controls are located. (1) \_\_\_\_\_ provide lift and support the plane while in flight. On the wings are moveable sections close to the plane's body called (3) \_\_\_\_\_ , which help the airplane fly slower for take-off and landing. Turns are made by moving the (3) \_\_\_\_\_ , which are on the outer part of the wings. When the airplane is on the ground the (3) \_\_\_\_\_ supports the plane. A retractable landing gear folds up inside the plane while in flight. A fixed landing gear does not fold. In the back of the airplane is the (4) \_\_\_\_\_ section. This section contains the (4) \_\_\_\_\_ , which moves to cause the plane to go up and down and the (1) \_\_\_\_\_ , which controls sideward movement.

*Solution appears on page 47.*

# Reproducible Activity

**Activity** \*Included with permission of NASA Aerospace Education Services Project

6\*

***Star Glider Pattern*** (on next page)

1. Cut wing and fuselage from foam deli tray.
2. Mark elevon hinge with roller ball pen using moderate pressure.
3. Cut slot in fuselage so wing fits snugly.
4. Slide wing in slot.
5. Tape penny on nose to balance.
6. Bend elevons upwards as needed.
7. FLY.

***Elevon***

Has dual function of aileron and elevator.

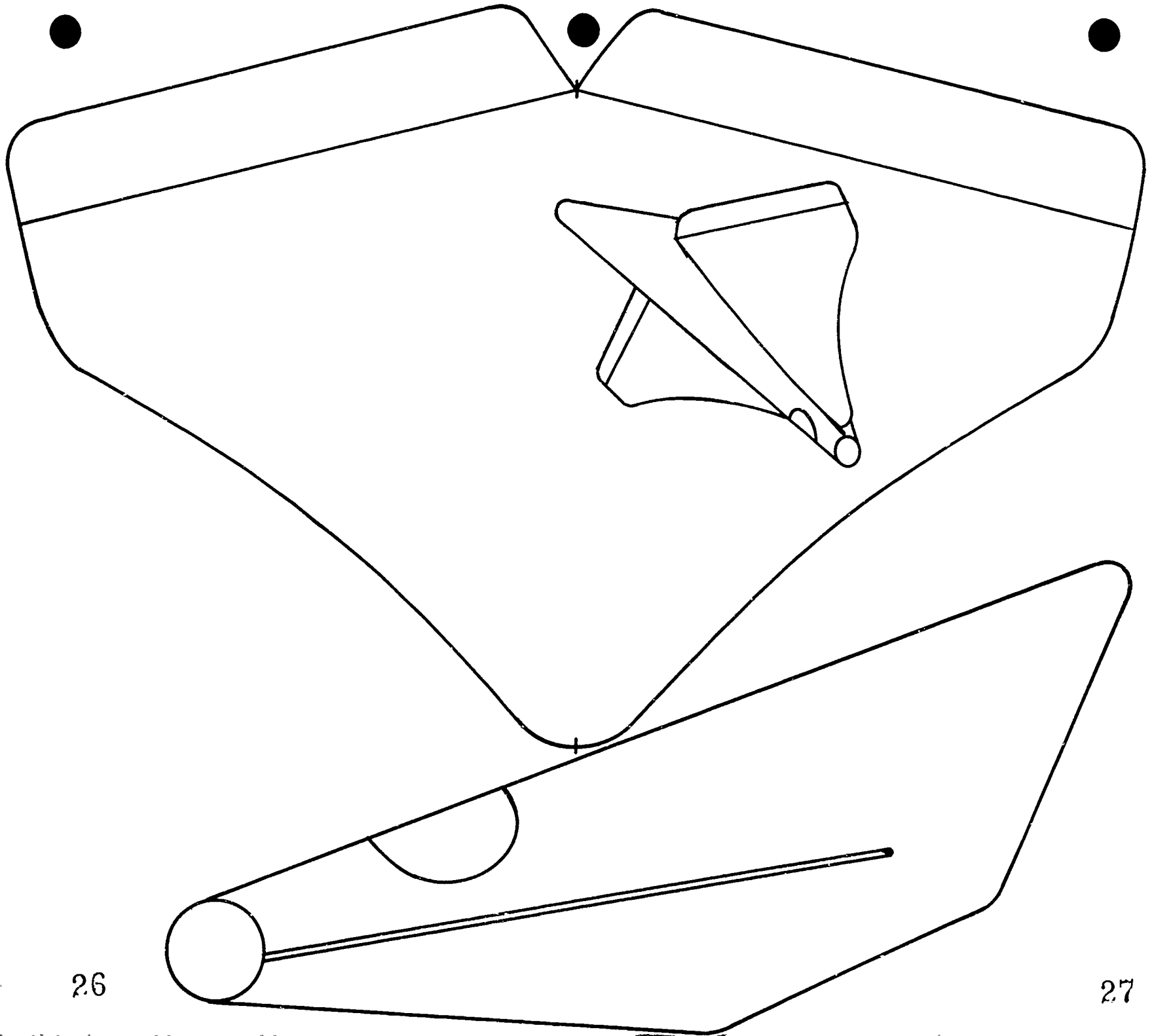

# Reproducible Activity

**Activity** 7 Important flights have insignias designed for them. Many of these are made into patches for people to collect or wear on clothing. Below is a picture of the insignia for the Apollo 11 flight. Design an insignia for a famous flight that could be made into a patch or used as a design for a T-shirt.

Famous insignia

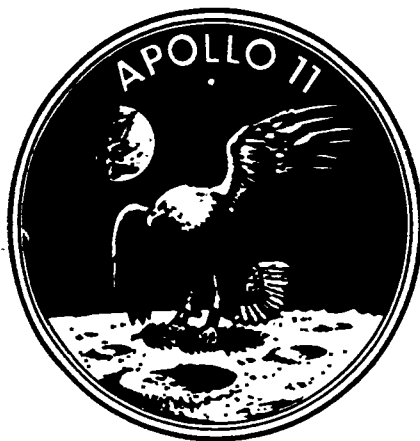

Your insignia

# Reproducible Activity

## Activity

8

Use the following three pages for making an Aviation and Space History timeline. Color and complete the drawings before cutting out the circles. There are four circles that need drawings. In one, draw yourself today, and in the other, draw yourself 15 years in the future. On the last two, you might draw one of your parents and one of your grandparents and label circles with the years they were born. Cut out all twelve circles. Then cut the timeline strips carefully on the dotted lines. Glue the strips together so that the result looks like a yardstick. Be sure the years are in the correct order before gluing. Place each circle over the year in which the event happened. Have your teacher check them before you glue. Hang your timeline at home and explain it to your family.

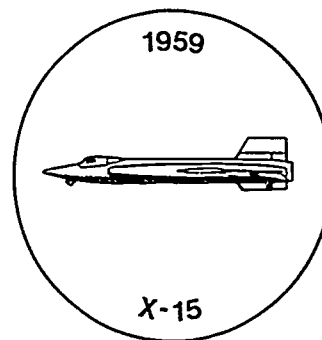
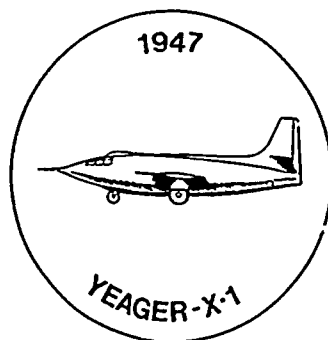
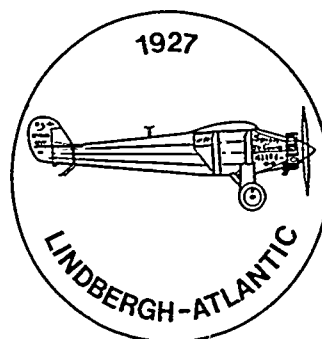
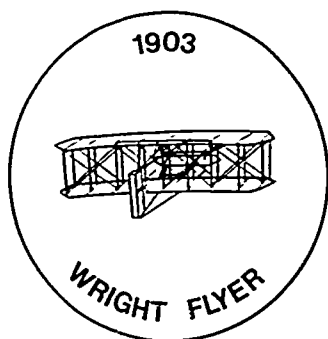

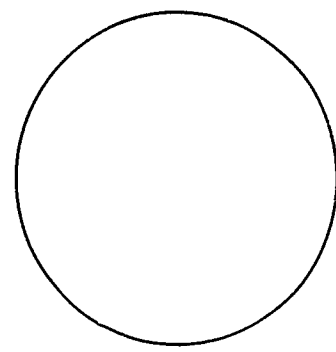
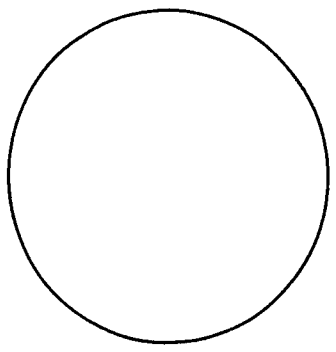
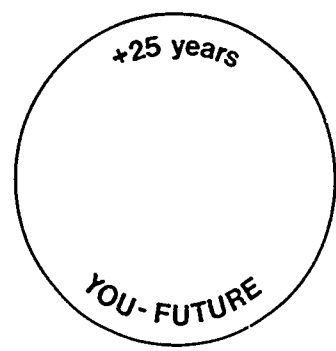
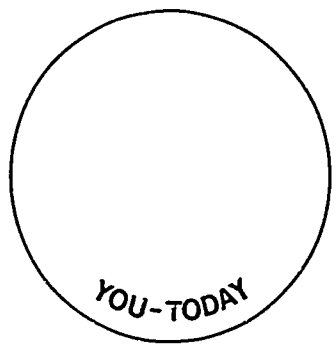
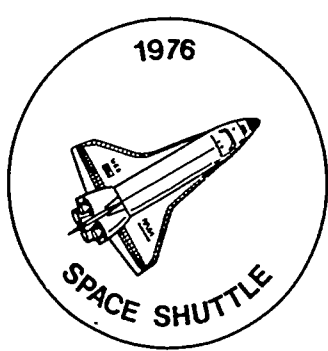
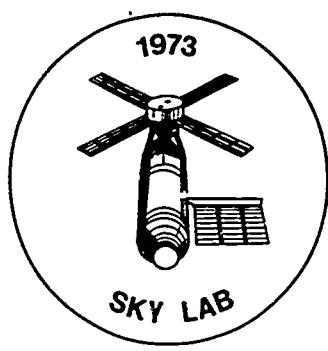
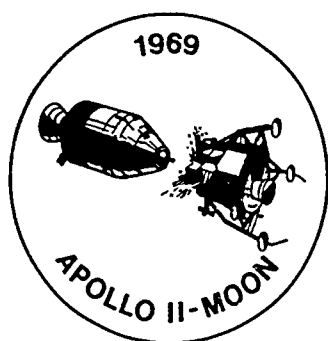
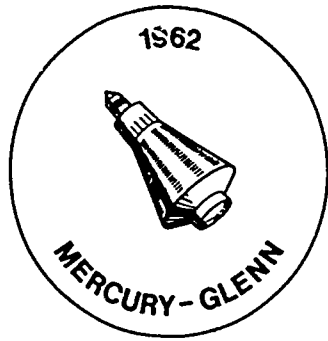



1900

1910

1920

GLUE

1930

1940

GLUE

1950

1960

1970

GLUE

1980

1990

2000

31

32

# Reproducible Activity

## Activity



Letters, numbers, signs, pictures, and words have been used to develop codes. This code uses numbers for letters. By using the code, can you decode the puzzle? Try making your own code and secret message. Give it to a friend to decode. Write a sentence about the answer to the decoded puzzle.

DECEMBER 17, 1903

CODE	1	2	3	4	5	6	7	8	9	10
	B	E	G	H	I	O	R	S	T	W

	4	5	3	0	2	5
	+6	+2	+2	+3	+2	+4

LETTER

—	—	—	—	—	—	—
—	—	—	—	—	—	—

	0	3	4	6	1	1	6	4
	+1	+4	+2	+3	+3	+1	+1	+4

LETTER

—	—	—	—	—	—	—	—	—
—	—	—	—	—	—	—	—	—

*Solution appears on pages 47 and 48.*

# Reproducible Activity

**Activity** - Letters, numbers, signs, pictures, and words have been used to develop codes. This code uses numbers for letters. By using the code, can you decode the puzzle? Try making your own code and secret message. Give it to a friend to decode. Write a sentence about the answer to the decoded puzzle.

10

JULY 20, 1969

CODE 10 59 9 26 33 48 65 88 76 41 17 97

A C D G I L M N O R S T

7 16 99 8 62 85 42 95 79  
+3 +25 -34 +9 +35 -44 +34 -7 -53

LETTER

\_\_\_\_\_  
\_\_\_\_\_

93 13 23 37 61 21  
-83 +35 -14 +4 -28 +67

LETTER

\_\_\_\_\_  
\_\_\_\_\_

13 87 22 93 16 53 59  
+46 -11 +26 -45 +17 +35 -42

LETTER

\_\_\_\_\_  
\_\_\_\_\_

*Solution appears on page 48.*

# Reproducible Activity

## Activity

# 11

Find words hidden in this word search. Read across, down, backwards, and diagonally.

### DISCOVERY WORD SEARCH

M C S P A C E C R A F T  
R O T A B H I M O P H U  
Z C N O O M Q U P A F Y  
E K O T D X F T A S L O  
N P O H G R E B D N I L  
N I L A Y O G U O R G H  
U T L X P I L O T O H T  
Q U A F R O Z F A C T H  
A D B L E B L I I K O G  
S K Y L A B Y L R E J I  
U R C N W A K P O T R R  
T F A R C R I A V N E W

Words to find:

Wright

Flight

Montgolfier

Balloon

Air

Cockpit

Pilot

Lindbergh

Aircraft

Rocket

Spacecraft

Apollo

Moon

Skylab

## Reproducible Activity

### Activity

# 12

The Saturn V launch vehicle was used in Apollo trips to the Moon and to place the Skylab Space Station in orbit. It was 110.6 meters (363 feet) tall, including the Apollo spacecraft, and had three stages.

Each stage had rocket engines to push the Saturn higher after the stage below it burned out.

The Saturn V was developed at the Marshall Space Flight Center in Huntsville, Alabama. The first Saturn V flight, November 9, 1967, was called Apollo 8. The sixth launch of a Saturn V was Apollo 11, the first manned flight to the surface of the Moon, in July 1969.

The Saturn V flew thirteen missions, three unmanned and ten manned. All were successful.

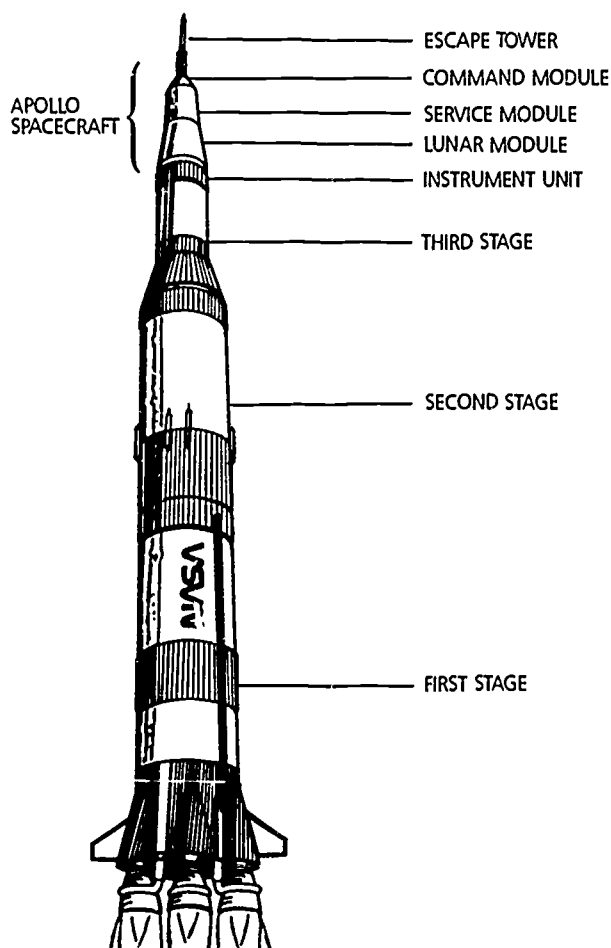

# Saturn V

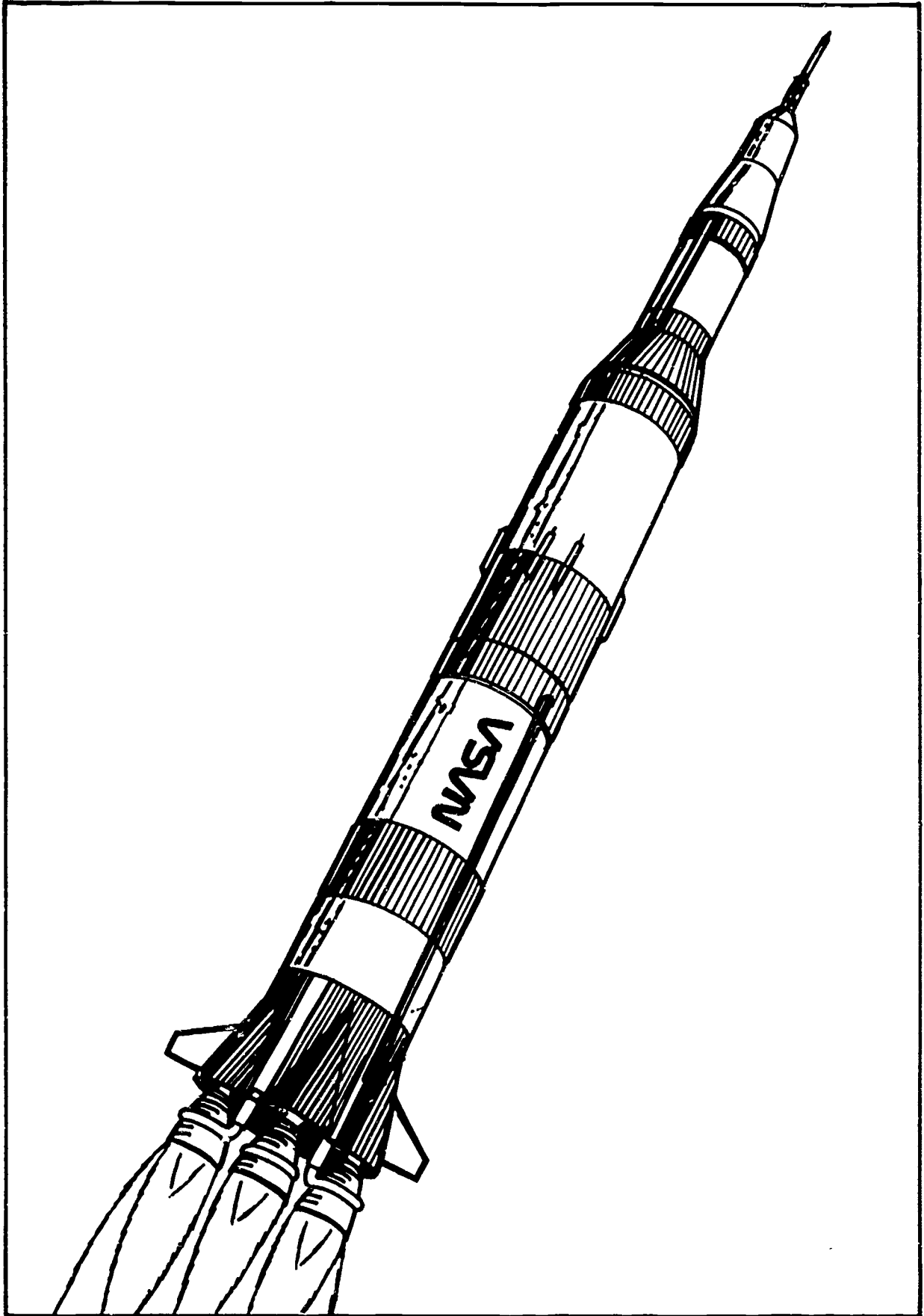

# Reproducible Activity

## Activity

# 13

The Lunar Roving Vehicle, or Lunar Rover, was a space "buggy." The astronauts used it to explore their landing sites on the Moon. They gathered Moon rocks and soil, and traveled much farther than they could have on foot. During Apollo 17, the rover traveled 19.3 kilometers (12 miles) on one of its three trips.

The rover was neatly folded up inside the lunar lander during trips to the Moon, but once on the Moon's surface, it unfolded with the help of springs. The Apollo 15, 16, and 17 missions made use of the Lunar Rover.

Because the lunar surface is rugged, the buggy was designed to climb steep slopes, to go over rocks, and to move easily over the sand-like surface. It was able to carry more than twice its own weight in passengers, scientific instruments, and soil samples.

The Marshall Space Flight Center in Huntsville, Alabama, developed the Lunar Roving Vehicle.

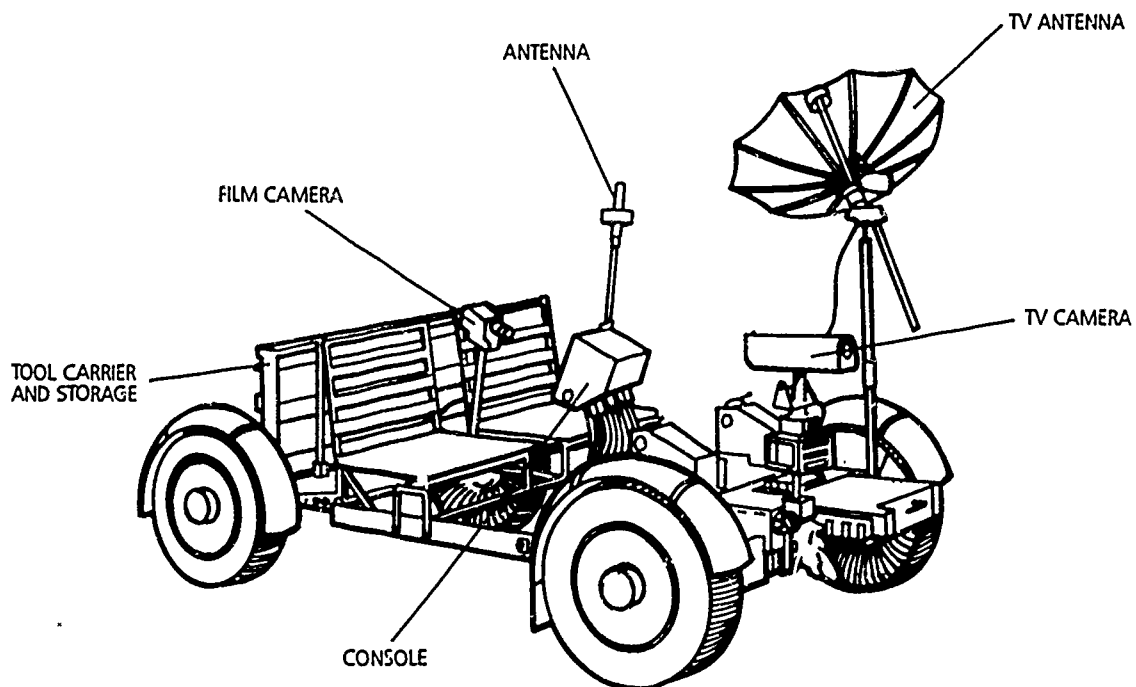



# Lunar Rover

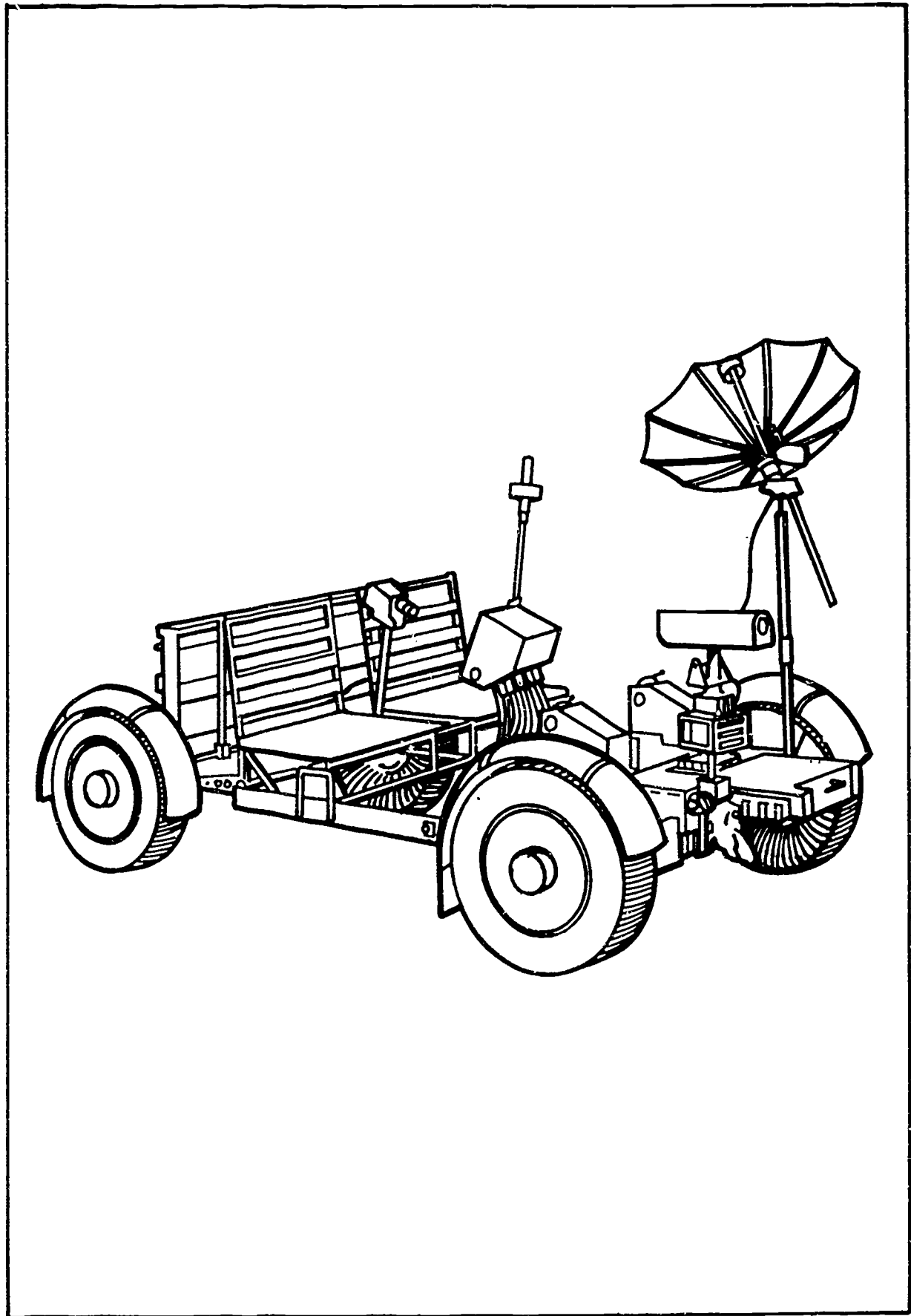

## Reproducible Activity

### Activity

14

The Apollo spacesuit had to provide the astronauts with protection. It had to protect them from temperatures ranging from  $-157$  to  $+121$  degrees Celsius ( $-250$  to  $+250$  degrees Fahrenheit). Not only did the Moon explorers' spacesuits have to offer protection from jagged rocks and the searing heat of the lunar day, but the suit also had to be flexible enough to permit stooping and bending as the crew gathered samples from the Moon.

A backpack portable life-support system provided breathing oxygen, suit cooling, and pressurization for moonwalks lasting up to eight hours.

From the body outward, the Apollo spacesuit began with a liquid-cooling garment similar to a pair of long underwear with a network of spaghetti-like tubing sewn into the fabric. Cool water, circulated through the tubing, transferred the body heat from the astronaut's body to the backpack, and then to space. The suit had a total of 21 layers of material.

The Apollo helmet was formed from high-strength Lexan plastic, and was attached to the spacesuit by a pressure-sealing neckring. While walking on the Moon, Apollo astronauts wore an outer visor over the bubble helmet to shield against eye-damaging ultraviolet radiation.  
(See spacesuit on reverse side)

# Spacesuit

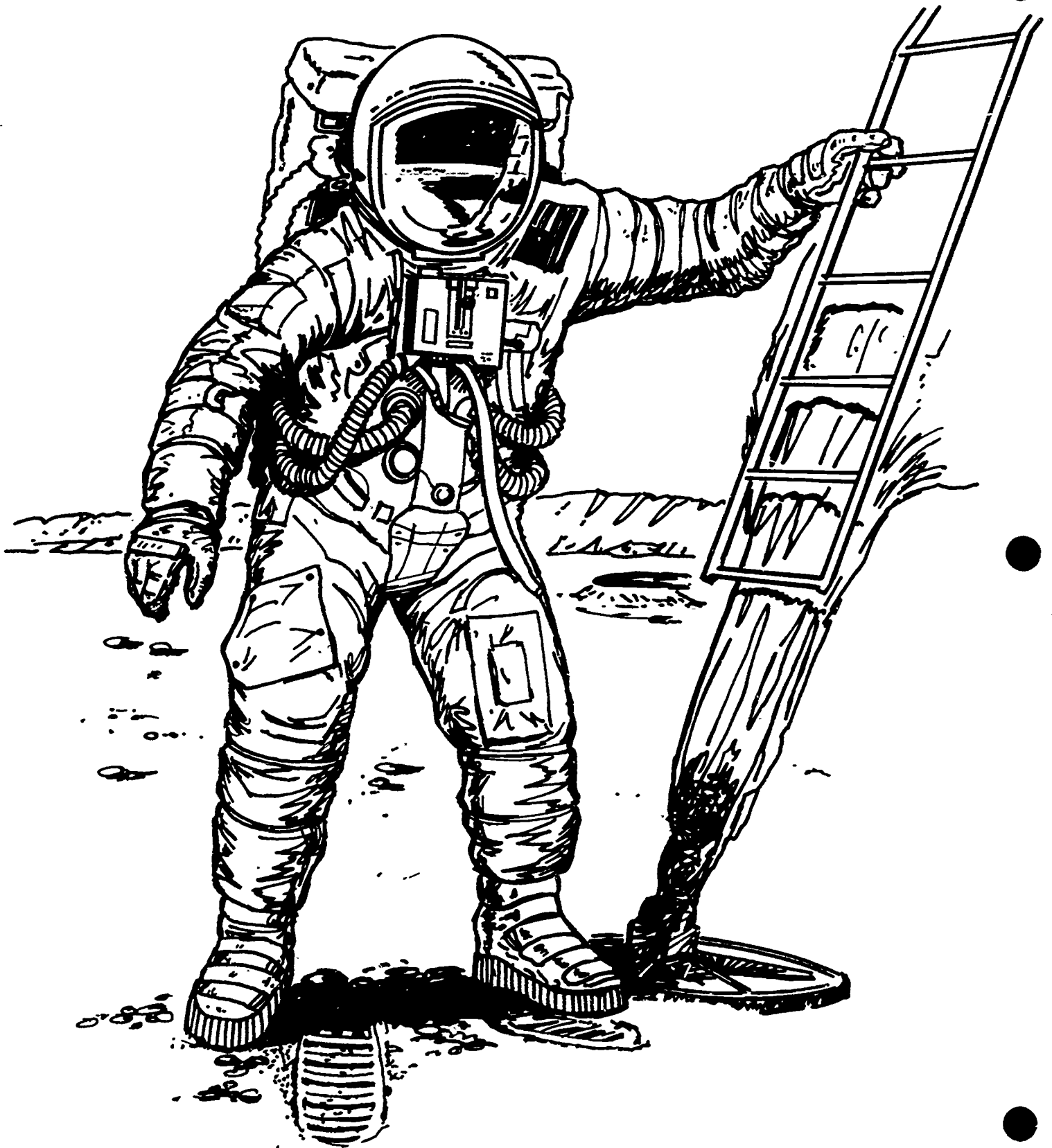

# Reproducible Activity

## Activity 15

Skylab was America's and the world's first Space Station. It was launched May 14, 1973. Skylab was made up of several parts. There were the big living and working quarters, the large arms called "solar arrays" to provide power for the spacecraft, and a passage for the astronauts to get in and out of Skylab while in space. A docking port let the astronauts attach the Apollo spacecraft to Skylab. The solar telescopes allowed the astronauts to study the Sun. A sunshield protected Skylab from the Sun's heat.

Three different crews of three men each flew missions to Skylab. The final mission lasted 84 days.

The Marshall Space Flight Center in Huntsville, Alabama, developed Skylab. Skylab reentered Earth's atmosphere on July 11, 1979.

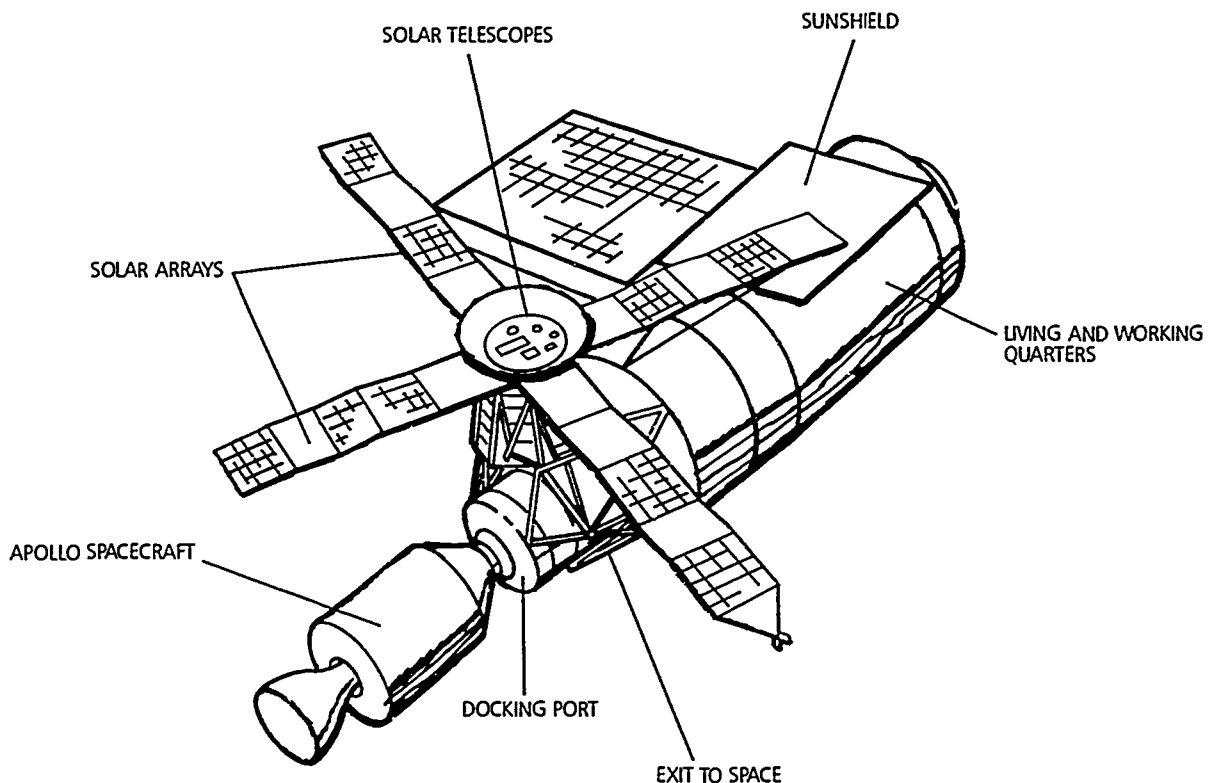

# Skylab

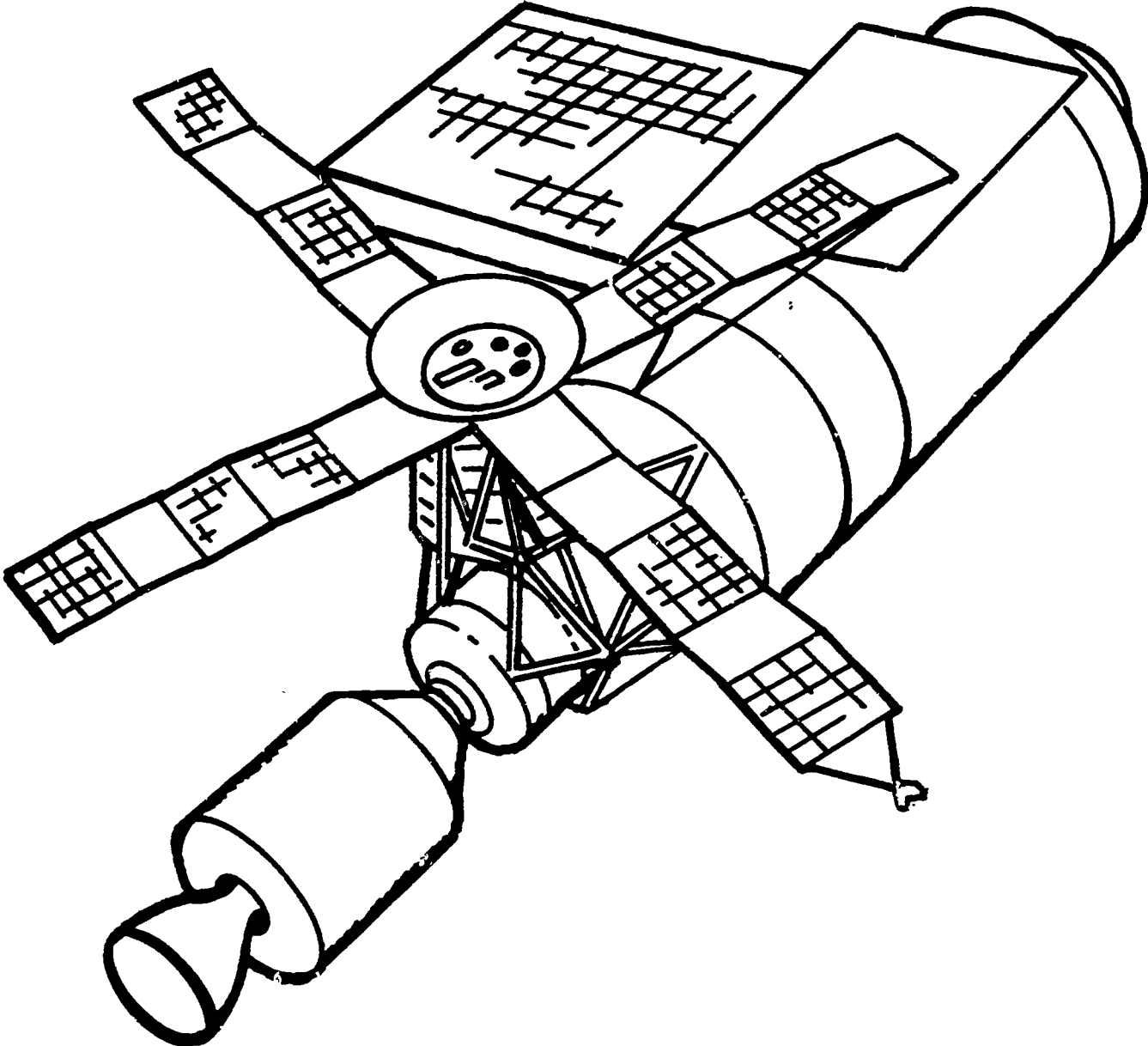

## Reproducible Activity

### Activity

16

The Space Shuttle is a spacecraft that can be used for many flights into space. It carries people and experiments to Earth orbit. Scientists and engineers ride in the Shuttle and operate experiments in space. Someday, the Shuttle may carry you to Earth orbit.

The Space Shuttle has four major parts: The orbiter, the Solid Rocket Boosters (two), the External Tank, and the set of three Space Shuttle main engines in the rear of the orbiter. Only the orbiter and the main engines go into Earth orbit. The other parts are for liftoff and powered flight.

NASA's Marshall Space Flight Center in Huntsville, Alabama, provides the boosters, the External Tank, and the main engines for the Space Shuttle.

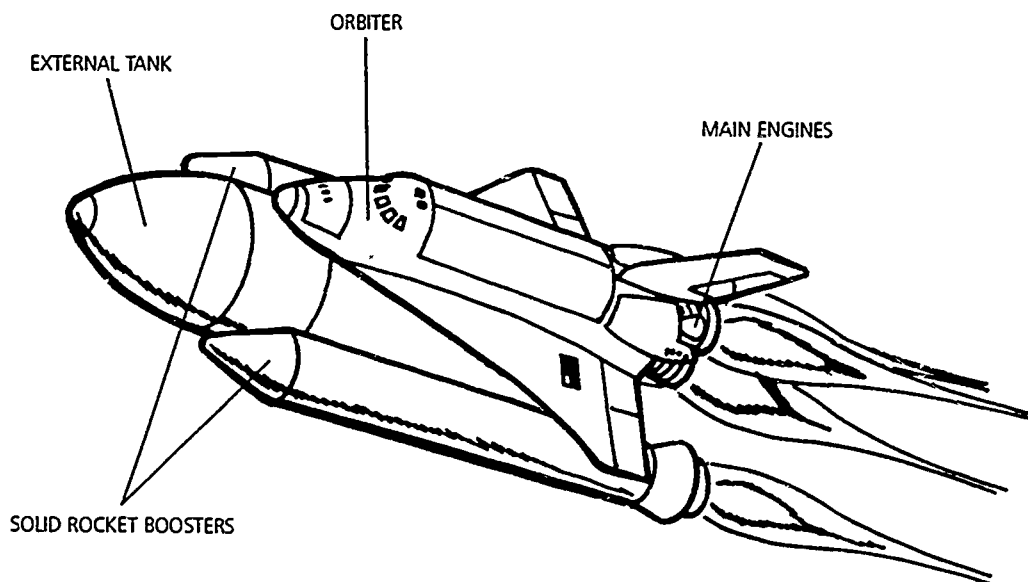

# Space Shuttle

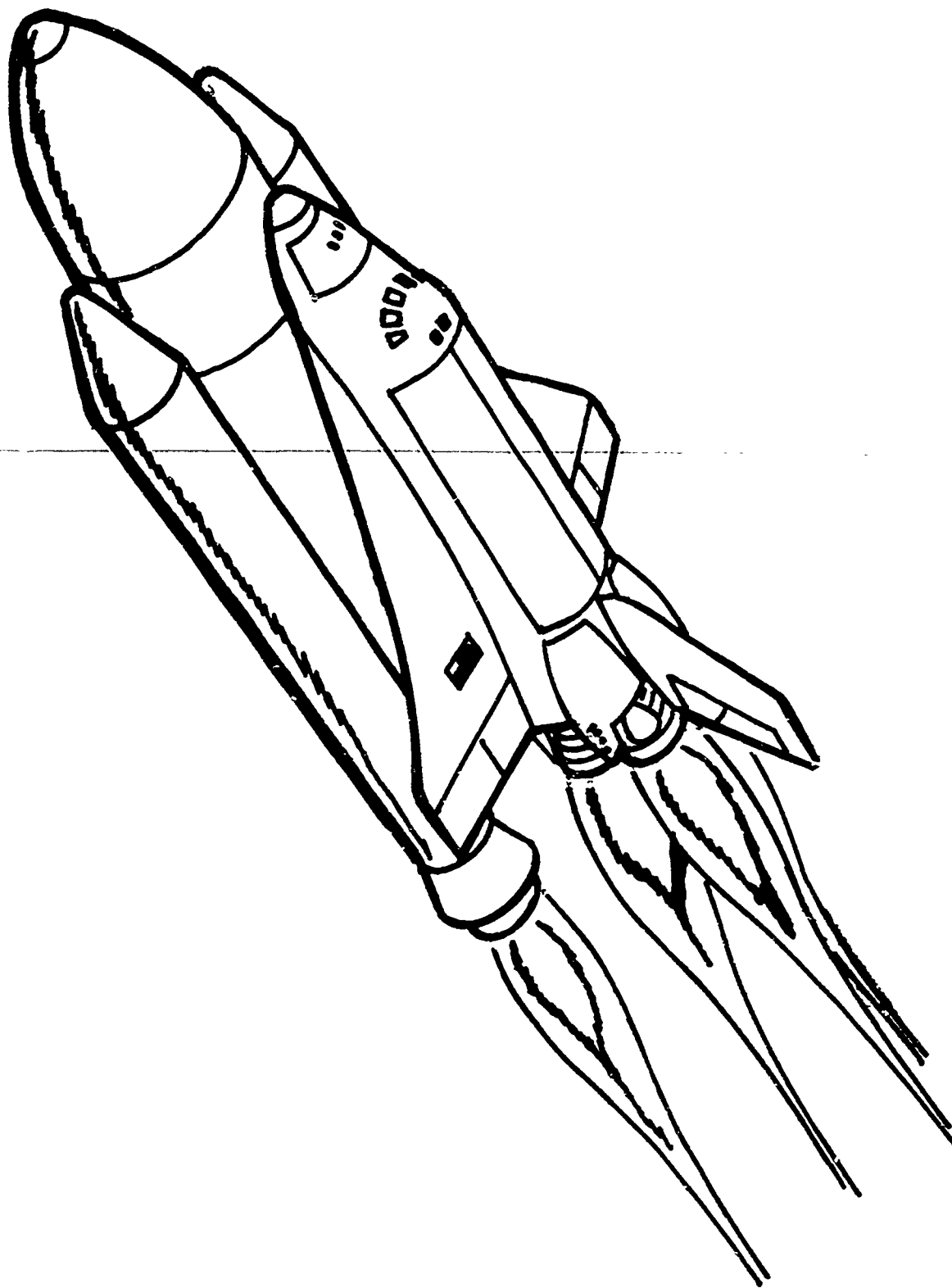

## Reproducible Activity

### Activity

17

NASA is making plans to build a Space Station. It will be a place for astronauts and scientists to live and work permanently in space. In the Space Station, they will make materials and medicines that cannot be made on Earth. They will study Earth, our solar system, and the stars. Experiments that need to be in space for long periods of time can be performed. Satellites can be prepared for trips further out into space. Trips to the Moon and planets will be easier from a Space Station.

NASA is building the Space Station to help make life better for all people.

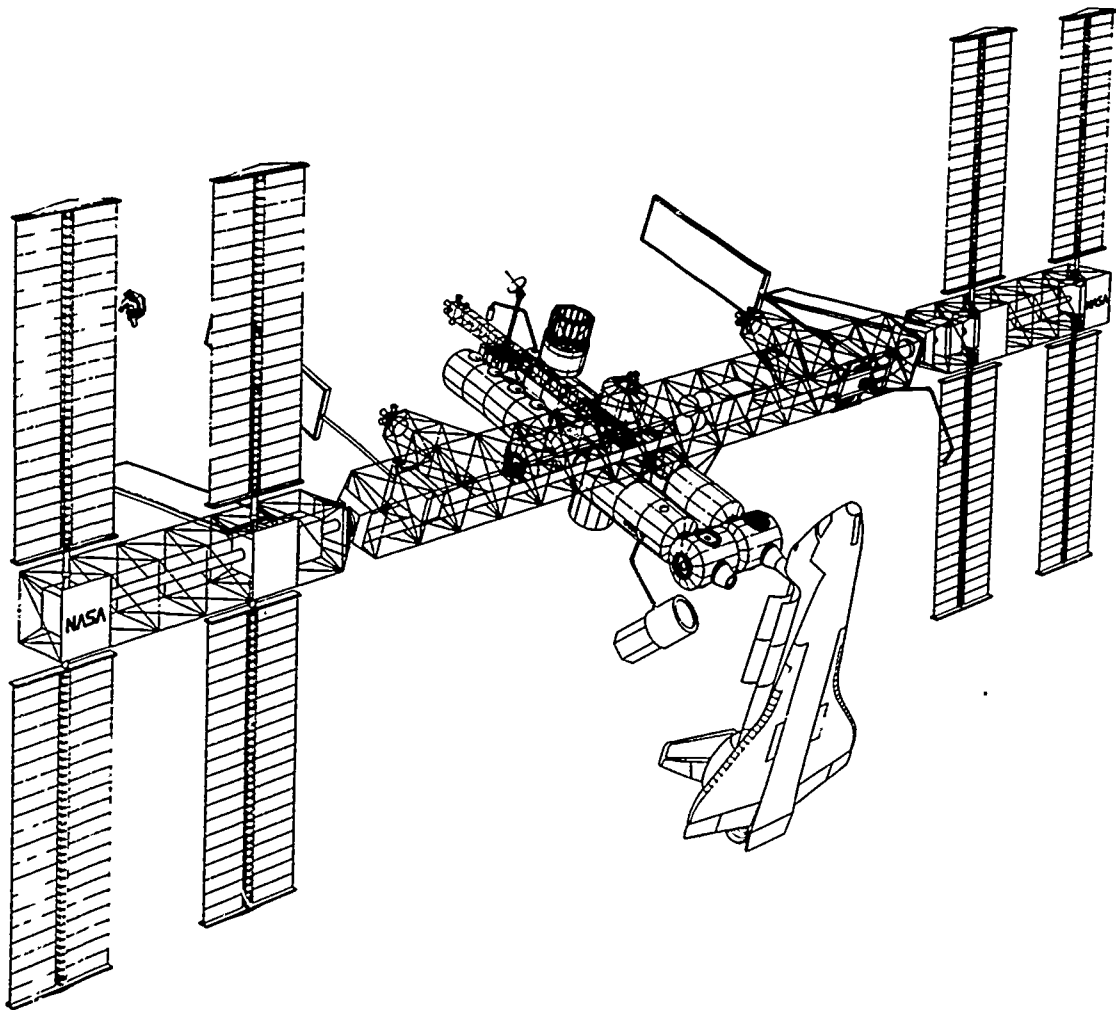



# Space Station

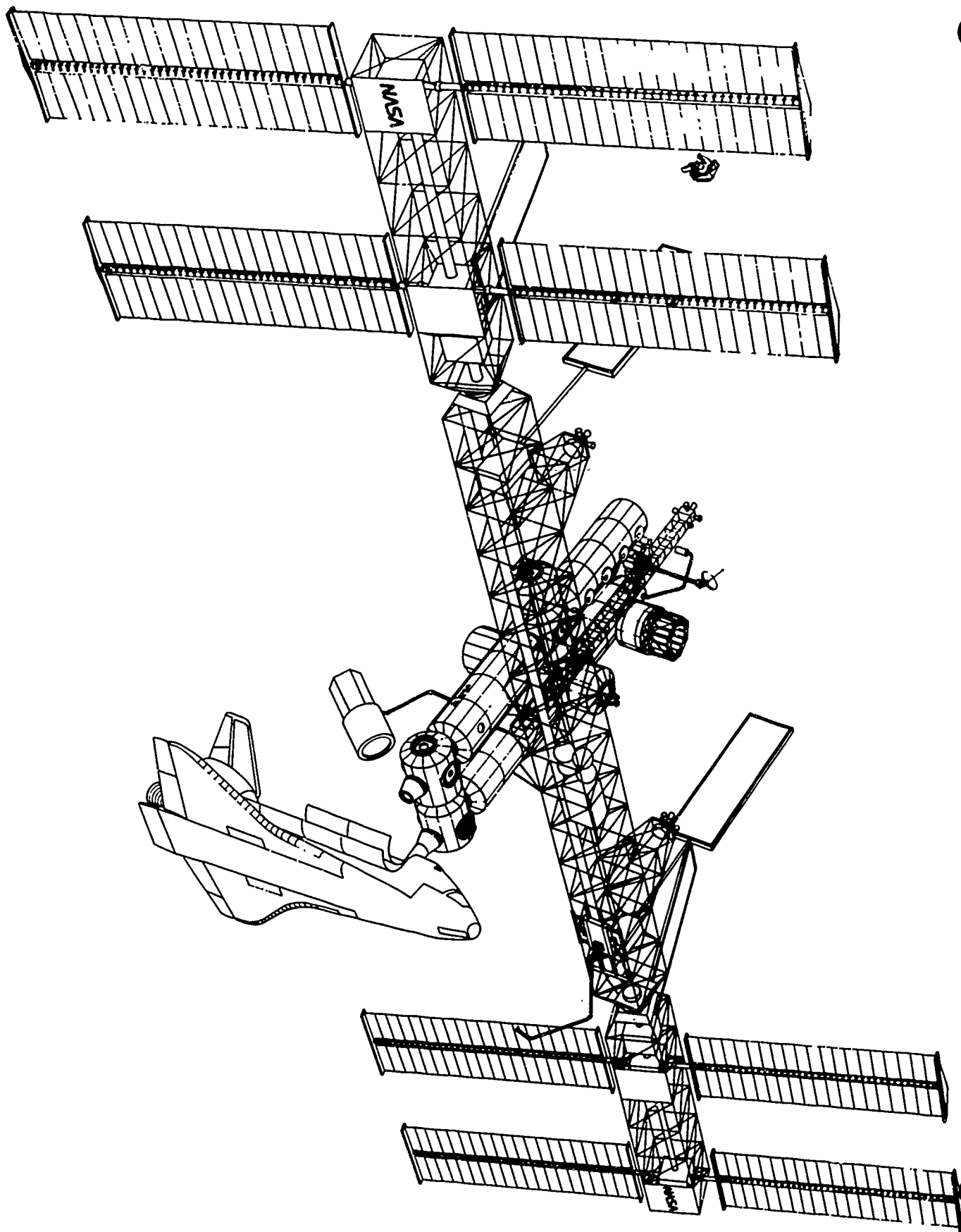

## Reproducible Activity

### Activity

18

NASA and the Department of Defense (DOD) have initiated a joint National Aero-Space Plane (NASP) research program. Imagine an aerospace plane of the future, one that would operate as an airplane at velocities greater than the speed of sound, or **hypersonic** velocities—6,400 to 12,800 kilometers (3,975 to 7,950 miles) per hour—in the upper atmosphere, flying to another continent in the Orient in two hours, or as a space launch vehicle flying from the runway directly to orbit, working in space, and returning for a conventional airport landing.

This is the vision for the 21st century—a family of reusable, economic aerospace-vehicles for rapid, long-distance, intercontinental transportation, as well as easy access to orbit from airport runways.

With the NASP program, NASA and the DOD are unifying the separate **hypersonic** research programs they have had for several years and bringing the dream to reality.

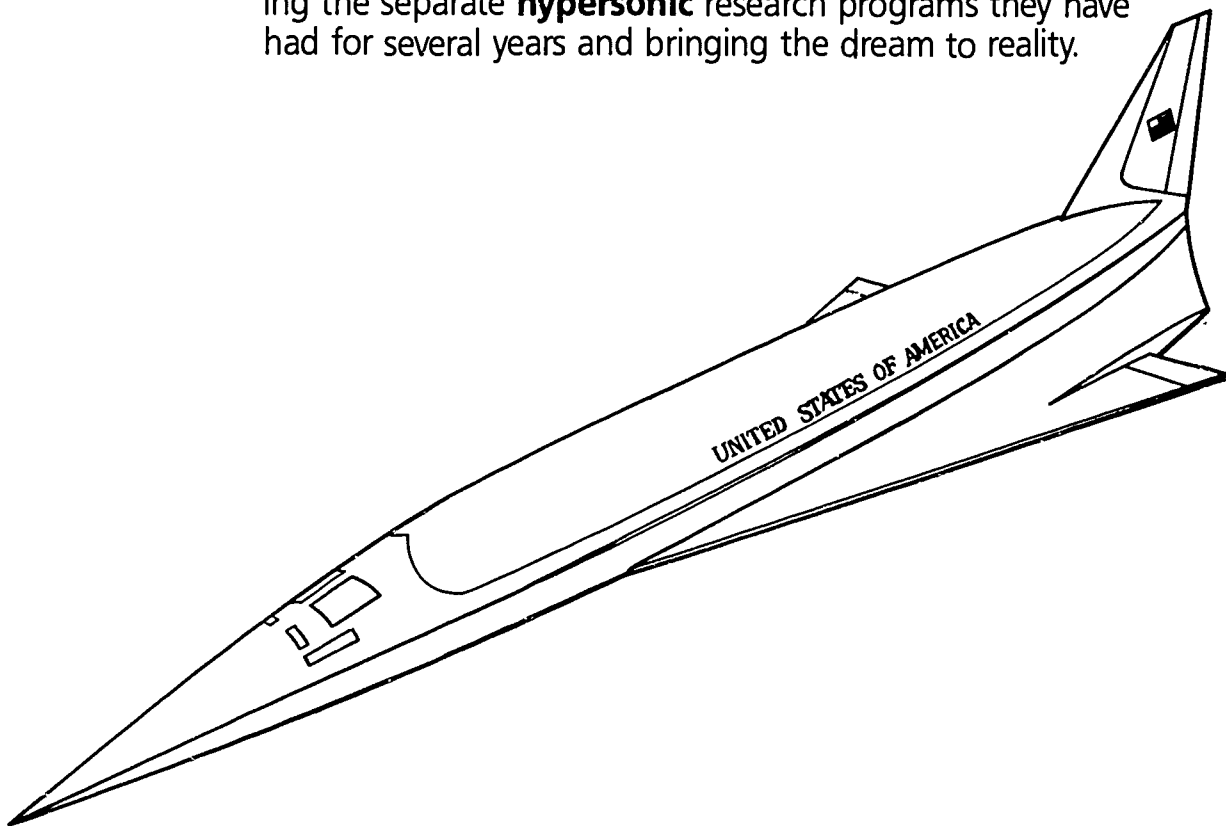

# Aero-Space Plane

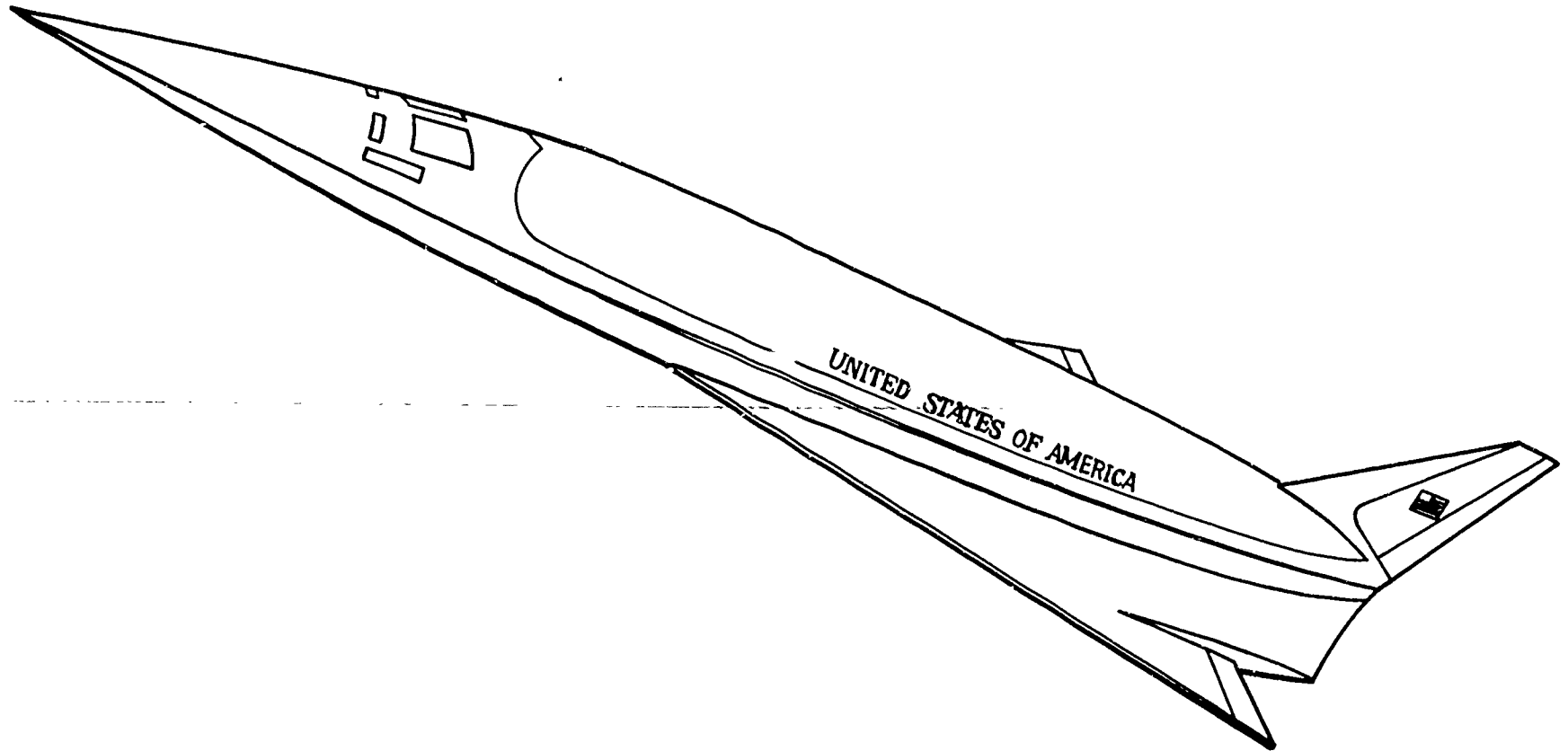

# Solutions to Reproducible Activities

## Activity

4

- |                      |                    |                       |
|----------------------|--------------------|-----------------------|
| 1) <u>(wings)</u>    | <u>(rudder)</u>    | <u>(fuselage)</u>     |
| 2) <u>(cockpit)</u>  | <u>(propeller)</u> | <u>(pilot)</u>        |
| 3) <u>(ailerons)</u> | <u>(flaps)</u>     | <u>(landing gear)</u> |
| 4) <u>(elevator)</u> | <u>(engine)</u>    | <u>(tail)</u>         |

## Activity

5

The teacher should share the following information about airplane parts and functions with students. The underlined words should be identified on the labeled airplane drawing. A variety of language arts activities could be devised utilizing the underlined vocabulary.

A **propeller** is a turning blade on the front of an airplane. The **engine** turns the propeller, which propels the airplane through the air. The main body portion of an airplane is the **fuselage**. The **pilot** flies the plane from the **cockpit** where the instruments and controls are located. **Wings** provide lift and support the plane while in flight. On the wings are moveable sections close to the plane's body called **flaps**, which help the airplane fly slower for take-off and landing. Turns are made by moving the **ailerons**, which are on the outer part of the wings. When the airplane is on the ground the **landing gear** supports the plane. A retractable landing gear folds up inside the plane while in flight. A fixed landing gear does not fold. In the back of the airplane is the **tail** section. This section contains the **elevator**, which moves to cause the plane to go up and down, and the **rudder**, which controls sideward movement.

## Activity

9

### ANSWERS TO PUZZLES

(Easy +)

DECEMBER 17, 1903

$$\begin{array}{r}
 4 \quad 5 \quad 3 \quad 0 \quad 2 \quad 5 \\
 + 6 \quad + 2 \quad + 2 \quad + 3 \quad + 2 \quad + 4 \\
 \hline
 10 \quad 7 \quad 5 \quad 3 \quad 4 \quad 9
 \end{array}$$

LETTER

W   R   I   G   H   T

(continued on back)

# Activity

## 9

(continued)

0	3	4	6	1	1	6	4
+ 1	+ 4	+ 2	+ 3	+ 3	+ 1	+ 1	+ 4
1	7	6	9	4	2	7	8

LETTER

<u>B</u>	<u>R</u>	<u>O</u>	<u>T</u>	<u>H</u>	<u>E</u>	<u>R</u>	<u>S</u>
----------	----------	----------	----------	----------	----------	----------	----------

# Activity

## 10

JULY 20, 1969

7	16	99	8	62	85	42	95	79
+ 3	+25	-34	+ 9	+35	-44	+34	- 7	-53
10	41	65	17	97	41	76	88	26

<u>A</u>	<u>R</u>	<u>M</u>	<u>S</u>	<u>T</u>	<u>R</u>	<u>O</u>	<u>N</u>	<u>G</u>
----------	----------	----------	----------	----------	----------	----------	----------	----------

93	13	23	37	61	21
-83	+35	-14	+4	-28	+67
10	48	9	41	33	88

<u>A</u>	<u>L</u>	<u>D</u>	<u>R</u>	<u>I</u>	<u>N</u>
----------	----------	----------	----------	----------	----------

13	87	22	93	16	53	59
+46	-11	+26	-45	+17	+35	-42
59	76	48	48	33	88	17

<u>C</u>	<u>O</u>	<u>L</u>	<u>L</u>	<u>I</u>	<u>N</u>	<u>S</u>
----------	----------	----------	----------	----------	----------	----------

# NASA and NASM Resource Centers

Teacher Resource Centers have been established to provide educators with NASA-related educational materials for use in the classroom. The materials include NASA publications, lesson plans, teacher guides, filmstrips, computer software, and audio cassettes, video tapes, 35-mm slides, and other reference materials.

Please contact the nearest Teacher Resource Center for further information.

NASA Ames Research Center  
ATTN: Teacher Resource Center  
Mail Stop 204-7  
Moffett Field, CA 94035

NASA Goddard Space Flight Center  
ATTN: Teacher Resource Laboratory  
Mail Code 130.3  
Greenbelt, MD 20771

NASA Jet Propulsion Laboratory  
ATTN: Teacher Resource Center  
JPL Education Outreach  
Mail Stop CS-536  
Pasadena, CA 91109

NASA Johnson Space Center  
ATTN: Teacher Resource Room  
Mail Stop AP-4  
Houston, TX 77058

NASA Kennedy Space Center  
ATTN: Educator Resource Library  
Mail Stop ERL  
Kennedy Space Center, FL 32899

NASA Langley Research Center  
ATTN: Teacher Resource Center  
Mail Stop 146  
Hampton, VA 23665-5225

NASA Lewis Research Center  
ATTN: Teacher Resource Center  
Mail Stop 8-1  
Cleveland, OH 44135

NASA Marshall Space Flight Center  
ATTN: Teacher Resource Room  
The Space & Rocket Center  
Tranquility Base  
Huntsville, AL 35807-0680

NASA National Space Technology  
Laboratories  
ATTN: Teacher Resource Center  
Building 1200  
NSTL, MS 39529

The Education Resource Center of the National Air and Space Museum in Washington, D.C., is open to educators on a walk-in or through-the-mail basis. An extensive collection of videos, computer software, slides, audio cassettes, and written materials are available for review and duplication.

Contact:  
The Education Resource Center  
Office of Education P-700  
National Air and Space Museum  
Smithsonian Institution  
Washington, D.C. 20560  
202/786-2109



## Study Prints

This last section of Discovery is the Study Prints. They may be reproduced or used for bulletin boards.

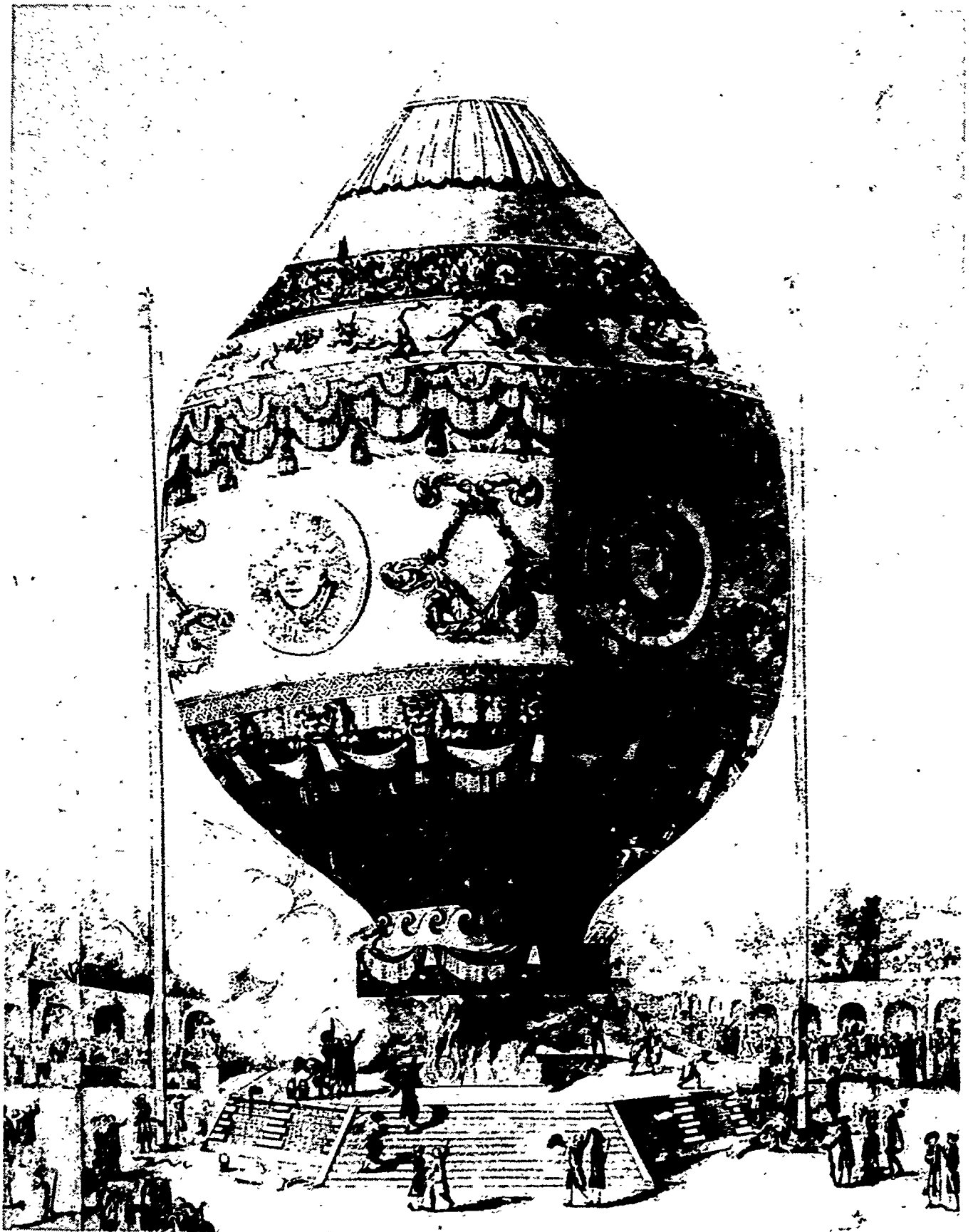





## Montgolfier Balloon

In the National Air and Space Museum is a  $\frac{1}{4}$ -scale model of the 21.3-meter (70-feet) tall hot-air balloon that carried men aloft for the first sustained aerial voyage. On November 21, 1783, Pilatre de Rozier and the Marquis d'Arlandes became history's first aeronauts when they ascended over Paris, France, in the highly decorated cloth balloon that was designed and built by Joseph and Etienne Montgolfier. The flight lasted 25 minutes, and the balloon reached an altitude of more than 914 meters (3,000 feet) before landing over 8 kilometers (five miles) from its starting point.

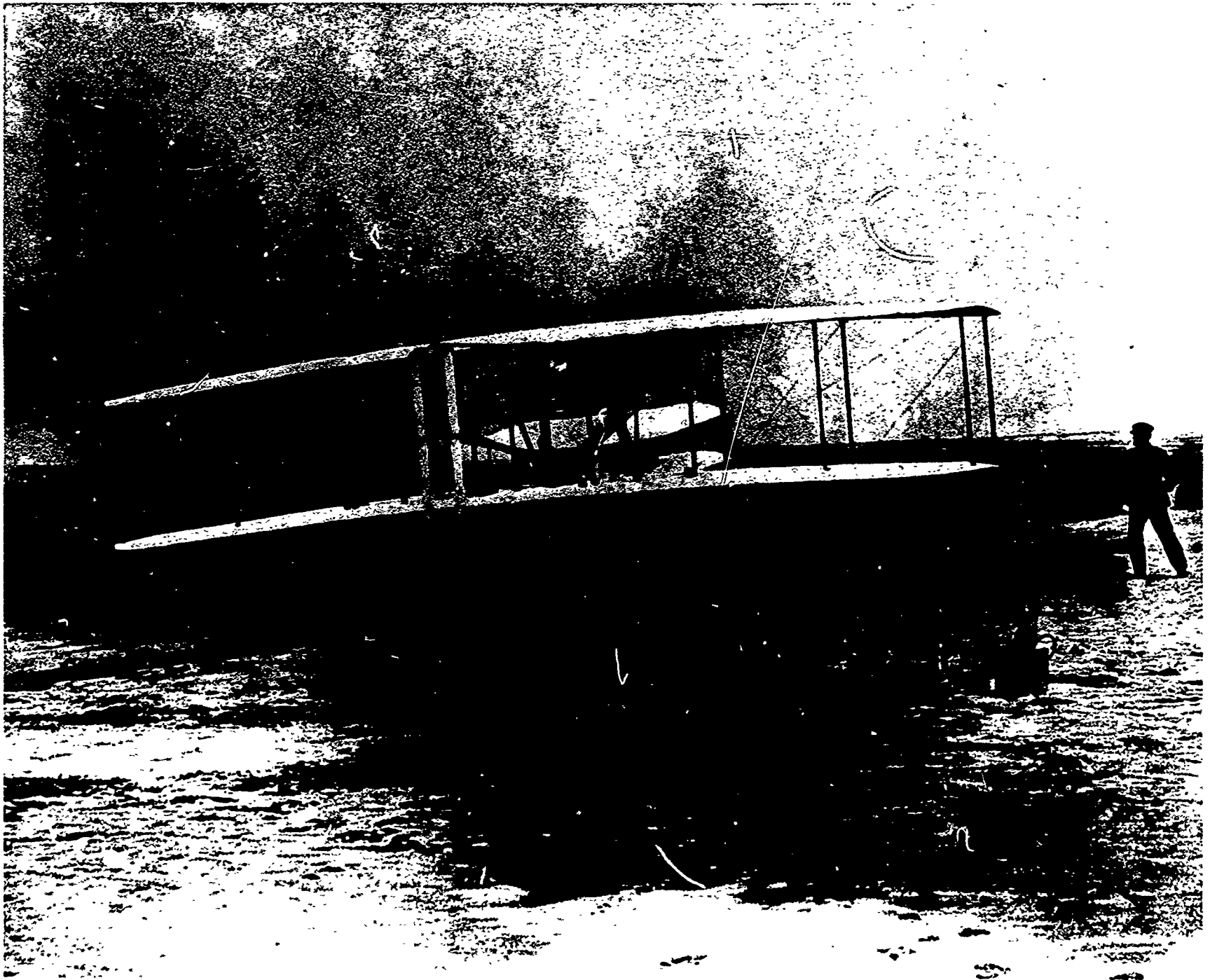



## Wright 1903 Flyer

The Wright 1903 Flyer is considered to be the world's first successful powered airplane. The plane flew four times, all on the same day, December 17, 1903. Orville Wright was the pilot for the first and third flights, and his brother Wilbur flew the airplane for the second and last flights. The fourth and longest flight was 59 seconds, and covered 260 meters (852 feet). The craft is made primarily of wood covered in cotton fabric, and is powered by a 12-horsepower, four-cylinder gasoline engine.

The Wright brothers receive credit for building and flying the first airplane for a number of reasons. It was heavier than air, and manned, powered, and controlled by the pilot. It was a sustained flight because the craft took off under its own power, raised itself off the ground, proceeded forward through the air, and landed at an altitude at least as high as that from which it had risen.

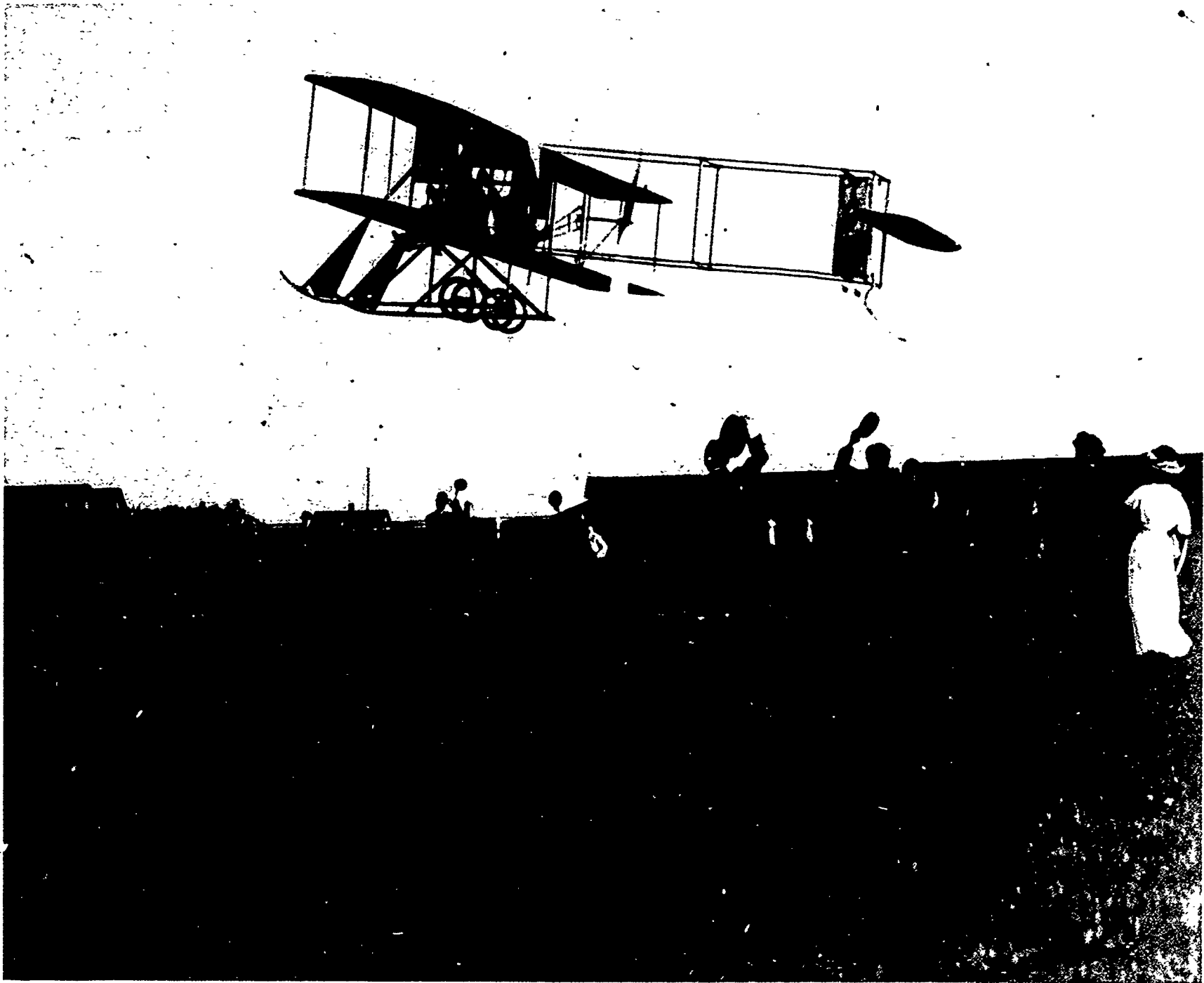



## Wright EX Vin Fiz

In 1911, in this airplane, Calbraith Perry Rodgers became the first person to make a U.S. transcontinental flight. He took off from Sheepshead Bay on Long Island in New York on September 17, 1911, and reached Pasadena, California, on November 5 of that same year. During the trip, Rodgers made 70 landings, and replaced enough parts to build about four aircraft.

The aircraft is made of wood, trussed with steel wire, and covered with a cotton fabric with a rubber covering. It is powered by a Wright 35-horsepower, four-cylinder gasoline engine. The craft is called the "Vin Fiz" after a grape-flavored soft drink that was being sold at the time by Rodgers' sponsor, the Armor Company of Chicago.





## Spirit of St. Louis

In this airplane, on May 21, 1927, Charles A. Lindbergh became the first person to make a solo transatlantic flight. Flying from New York, New York, to Paris, France, he covered the 5,810 kilometers (3608 miles) in 33 hours 30 minutes. The airplane is small, made of wood, steel tubing, and fabric, and is powered by a single 223-horsepower Wright Whirlwind J-5-C engine.

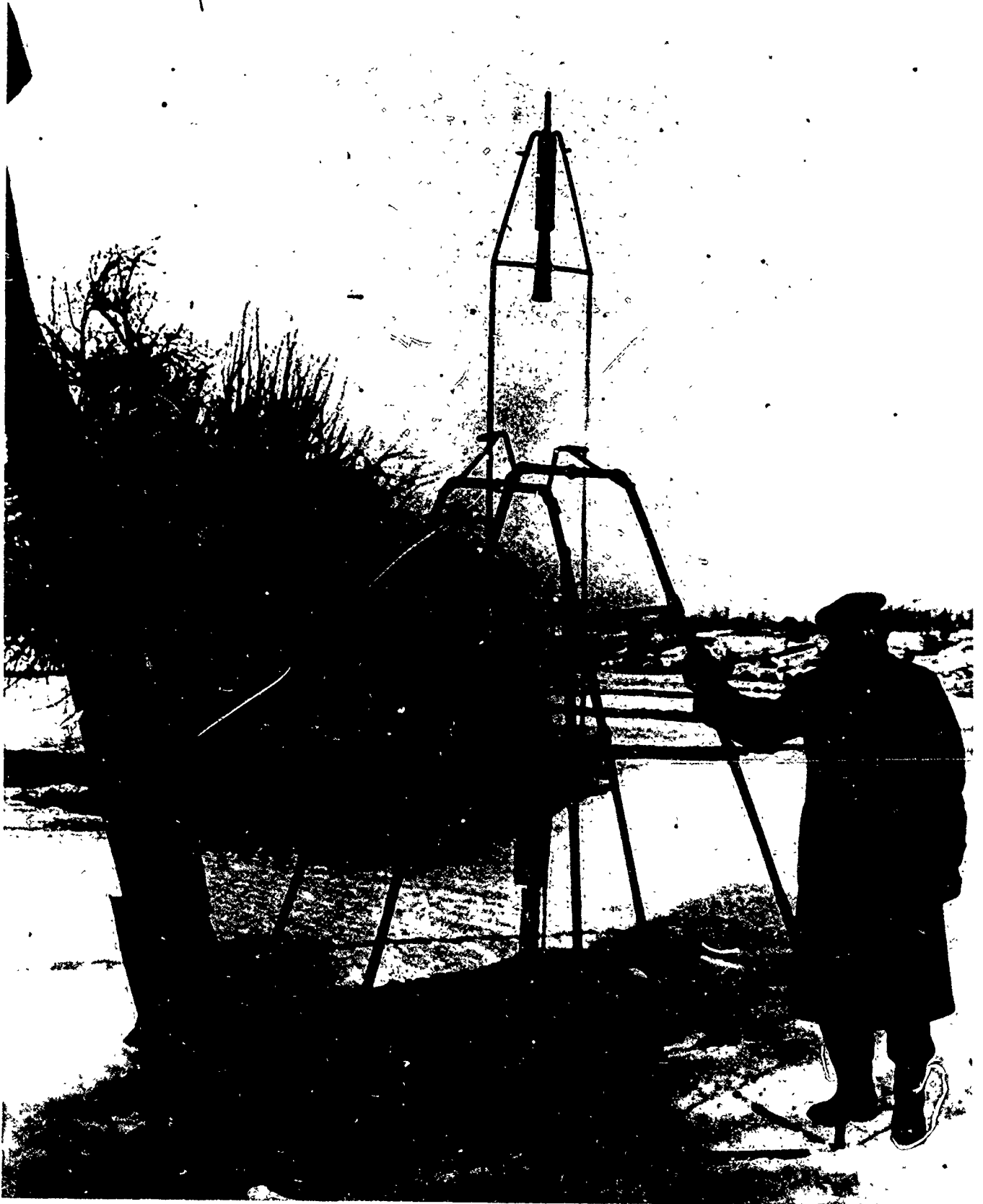





## Goddard 1926 Rocket

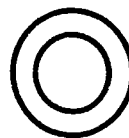

On March 16, 1926, Dr. Robert H. Goddard successfully launched the world's first liquid-fuel rocket. It rose 12 meters (40 feet), and landed 56 meters (184 feet) away, in a flight that lasted 2.5 seconds. This rocket was the forerunner of all liquid-fuel rockets. The rocket and launching-stand now on display in the National Air and Space Museum are replicas. The originals no longer exist.





33278 A C

68

69



## Bell X-1

This rocket-powered research aircraft, patterned on the lines of a .50-caliber machine gun bullet, was the first manned vehicle to fly faster than the speed of sound. The speed of sound (Mach 1.00) varies with altitude. On October 14, 1947, the X-1 was carried aloft under the bomb bay of a B-29 bomber, then released. The pilot of the X-1, Air Force Captain Charles "Chuck" Yeager, ignited the Reaction Motors XLR-11-RM-3 engine, climbed and accelerated, reaching Mach 1.06, or 1127 kilometers (700 miles), per hour. He flew over the Mojave Desert in California at an altitude of 13.1 kilometers. (At this altitude, Mach 1.00 is 1078.7 kilometers (670 miles) per hour. The aircraft, having used all of its fuel, glided to a landing on its tricycle landing gear at Muroc Dry Lake, California.





## North American X-15

The North American X-15 rocket-powered research aircraft bridged the gap between manned flight within the atmosphere and manned flight into space. Although it has not flown since 1968, the X-15 flew higher and faster than any other winged aircraft, except for the Space Shuttle. In the 1960s, the X-15 flew more than six times the speed of sound, and reached an altitude of 107.8 kilometers (67 miles). It has all the normal movable surface controls of an aircraft, plus rocket thrusters for high-altitude control.

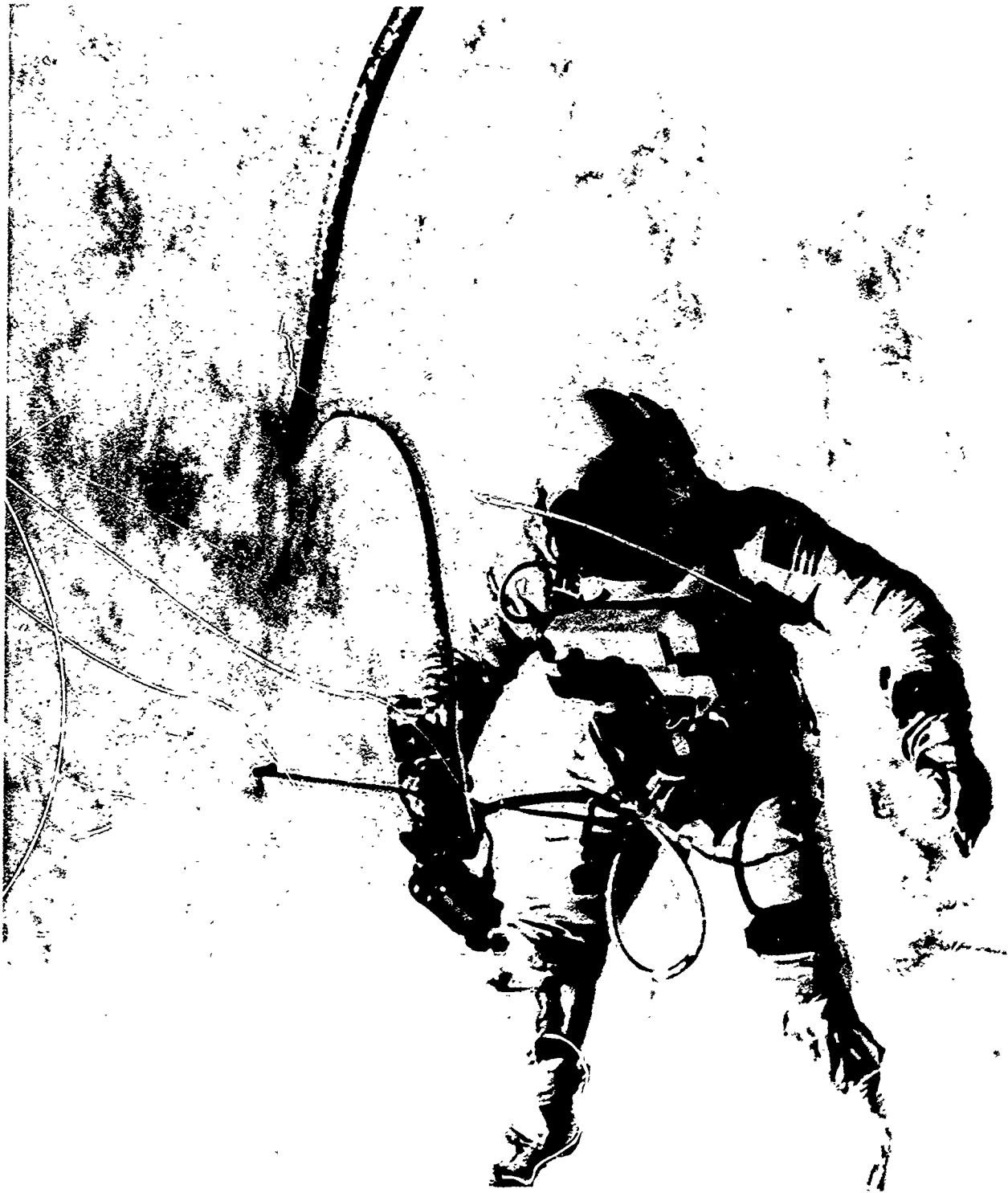



## Gemini 4

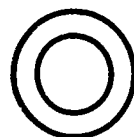

On June 3, 1965, astronaut Edward H. White II became the first American to walk in space, from the Gemini 4 spacecraft. Command pilot James A. McDivitt remained inside the depressurized cabin while White, connected to the craft by a 7.6-meter (25-foot) tether, floated outside for 22 minutes during the four-day flight.

A total of 10 manned Gemini missions were flown, from March 1965 to November 1966, all in spacecraft similar to the one pictured. Objectives of Project Gemini were to perfect techniques of docking and rendezvous, to conduct missions lasting up to two weeks, and to perform extravehicular activities (or space walks). In December 1965, Gemini 7 performed the world's first rendezvous in space by docking with Gemini 6. Gemini 7 stayed in orbit for 14 more days.







## Apollo 11 Command Module 'Columbia'

**A**pollo 11 was the first mission to carry men to a landing on the Moon. In July 1969, Neil Armstrong, Edwin Aldrin, and Michael Collins rode in the command module Columbia to the vicinity of the Moon. For the actual landing on the Moon, Armstrong and Aldrin transferred to the lunar module; Collins remained in the command module, orbiting the Moon alone until they rejoined him. The command module is the only section of the Apollo spacecraft covered with a protective heat shield, and the only section that returned to Earth.

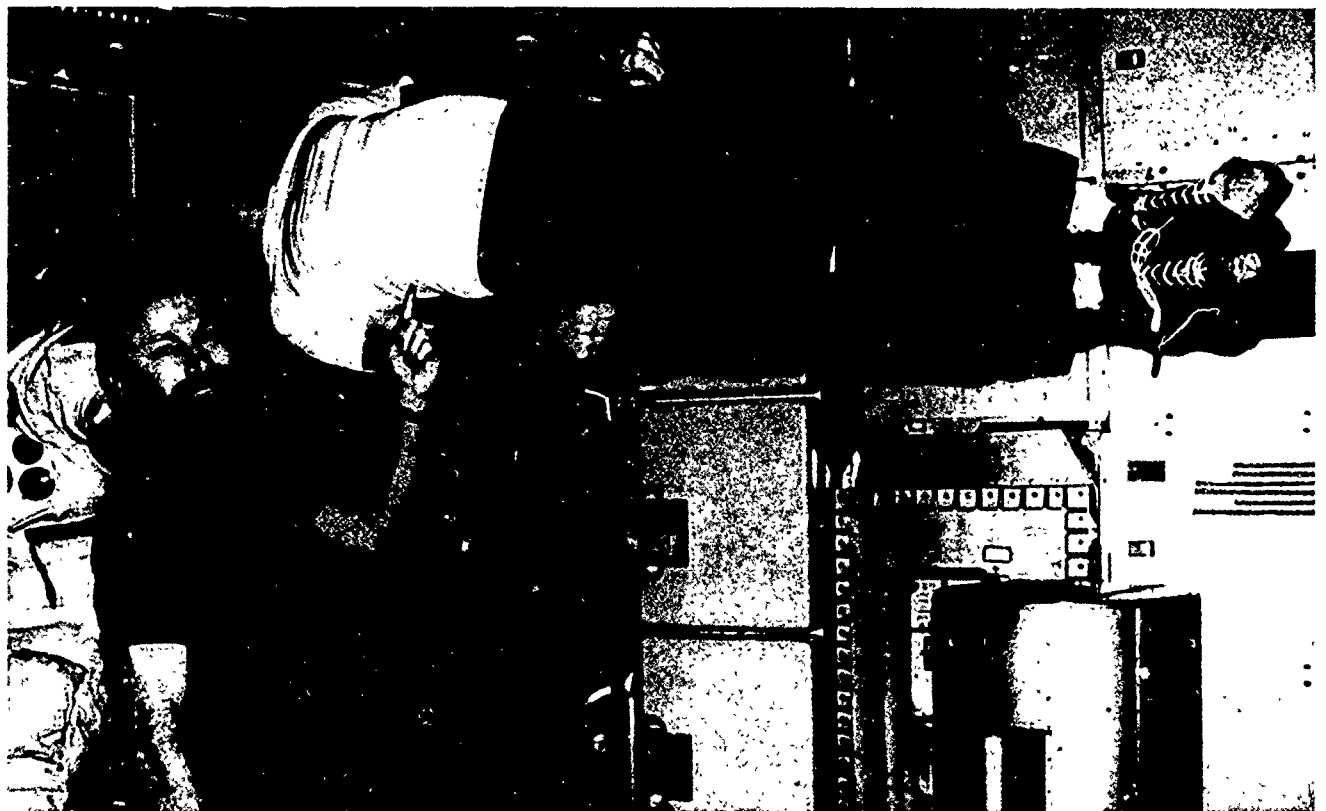
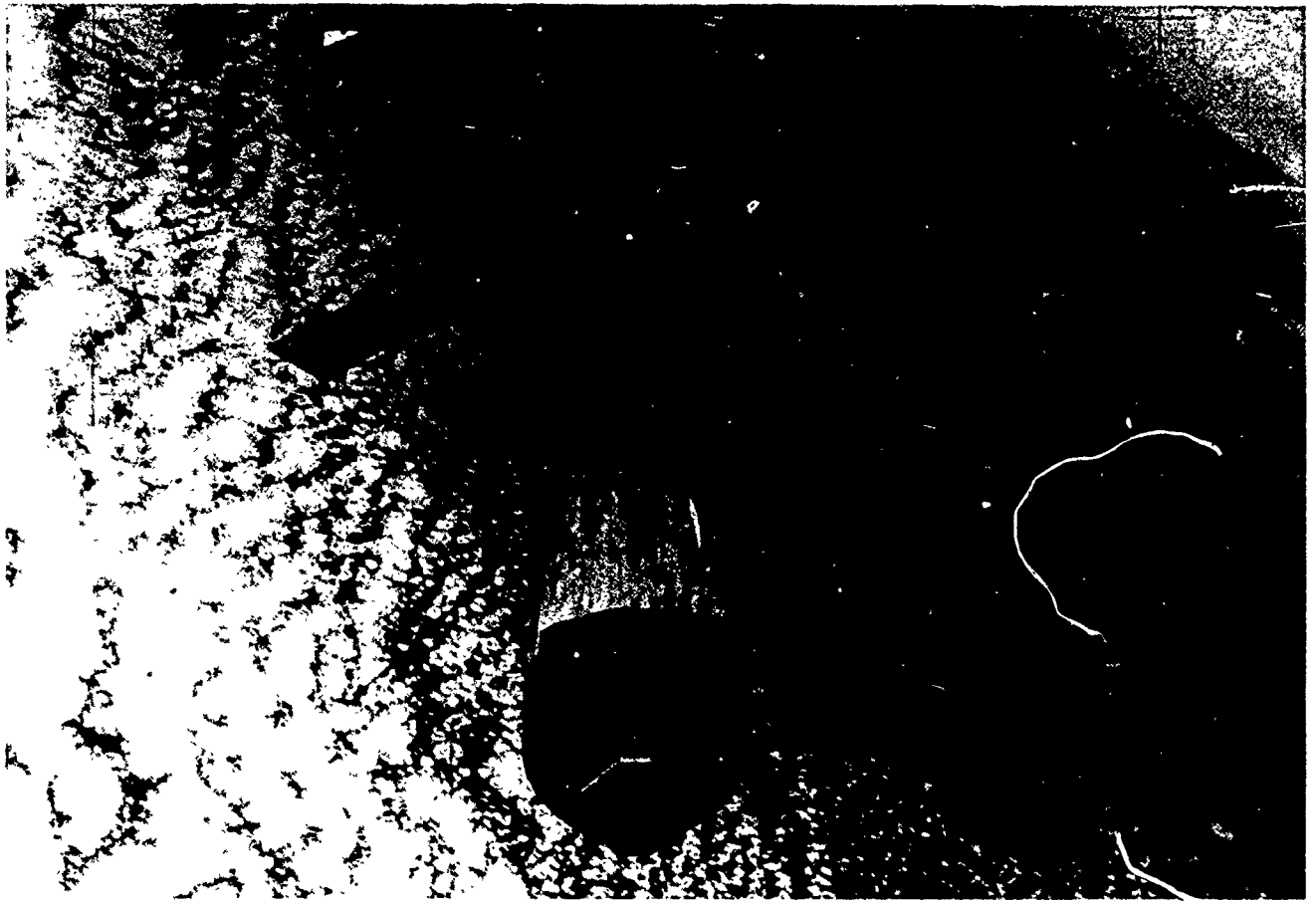



## Skylab

**A**s of 1986, the United States has had only one space station in orbit. It is called Skylab. To date, it is the largest satellite ever orbited, consisting of four major elements: the Multiple Docking Adaptor, the Airlock Module, the Orbital Workshop, and the Apollo Telescope Mount. Skylab weighed 100 tons when it was launched, unmanned, on May 14, 1973. During the next nine months, Skylab was occupied in succession by three teams of three-man crews. These crews spent 28, 59, and 84 days, respectively, orbiting the Earth and performing nearly 300 experiments.

Skylab then remained in orbit, unoccupied, until it reentered Earth's atmosphere on July 11, 1979. Most of the craft burned on reentry, although some pieces fell harmlessly into the Indian Ocean and the Australian desert.

The Skylab segments on display in the National Air and Space Museum are the flight backups that are flight worthy and would have been used if a segment of Skylab had needed replacement.

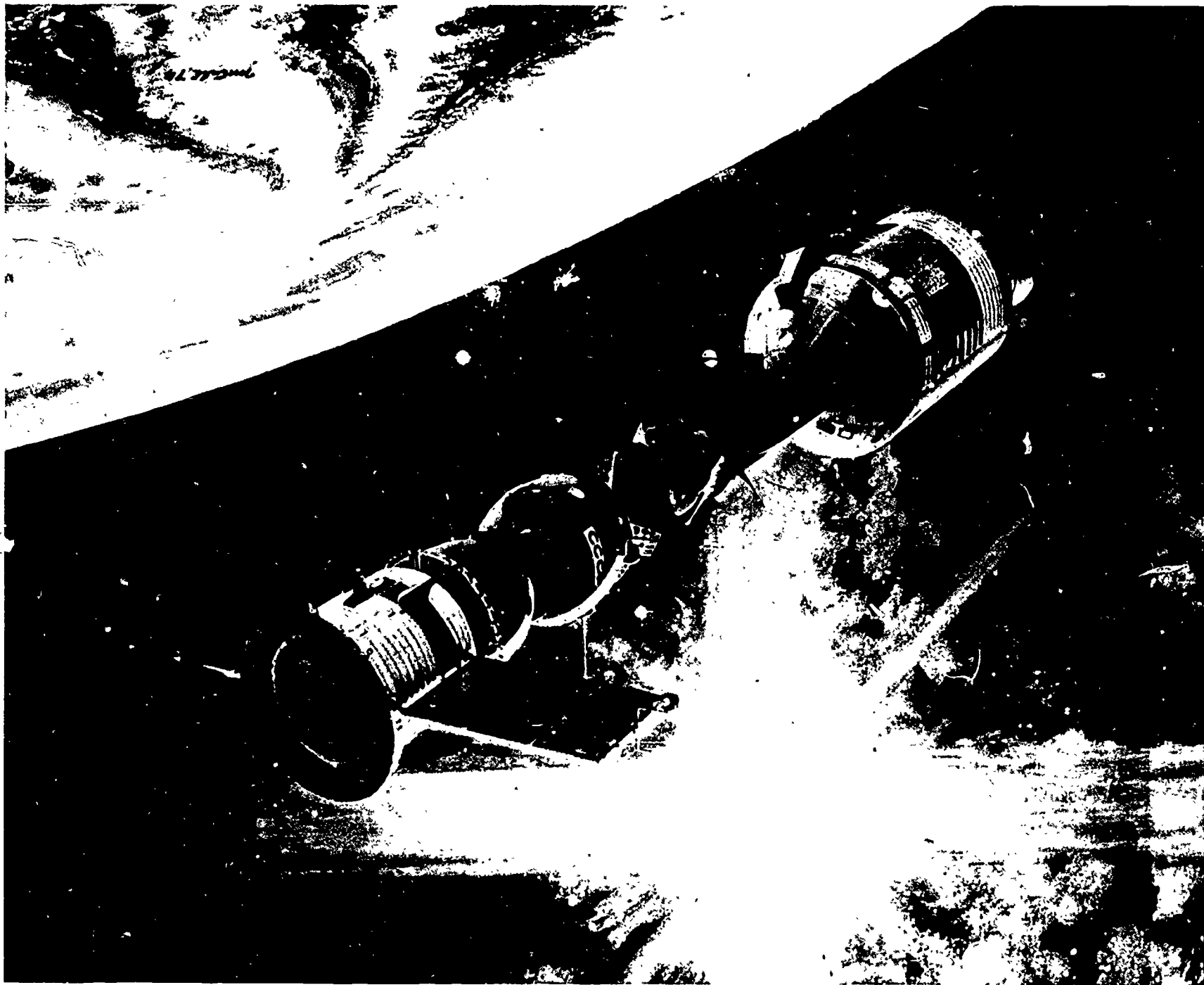

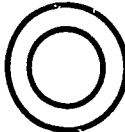

## Apollo-Soyuz

n July 17, 1975, three American astronauts in an Apollo command and service module docked with two Soviet cosmonauts in a Soviet Soyuz spacecraft. This was the first international manned space flight. During the two-day linkup, the crew members visited each spacecraft, shared meals, exchanged gifts, and conducted joint scientific experiments. The two spacecraft, on display in the National Air and Space Museum are representative of those used in the mission, but they have never been in space.

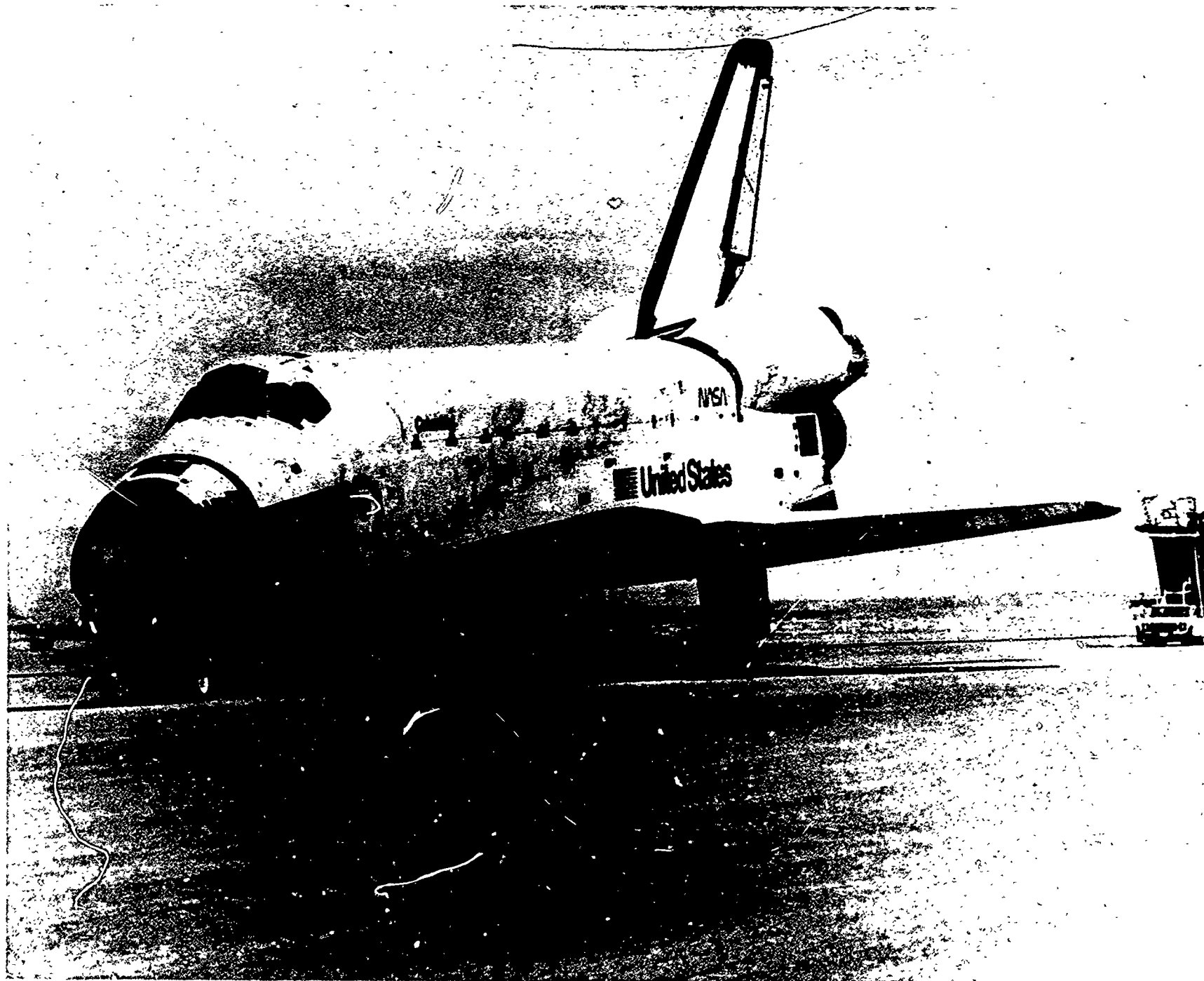



## Space Shuttle

**T**he Space Shuttle, the world's first reusable spacecraft for hauling people and cargo to and from space, was launched on April 12, 1981. Its many uses include launching satellites and housing scientific laboratories and materials-processing units. The Shuttle orbiter is launched as if it were a rocket, and it returns to Earth as if it were a glider. The Columbia is one of four shuttles built for space flight. A fifth shuttle, Enterprise, was built for unpowered landing tests only, and it is in the National Air and Space Museum's collection.